



World Health
Organization

WHEELCHAIR SERVICE TRAINING PACKAGE

Reference Manual for Participants

BASIC LEVEL



USAID
FROM THE AMERICAN PEOPLE



**World Health
Organization**

WHEELCHAIR SERVICE TRAINING PACKAGE

Reference Manual for Participants

BASIC LEVEL

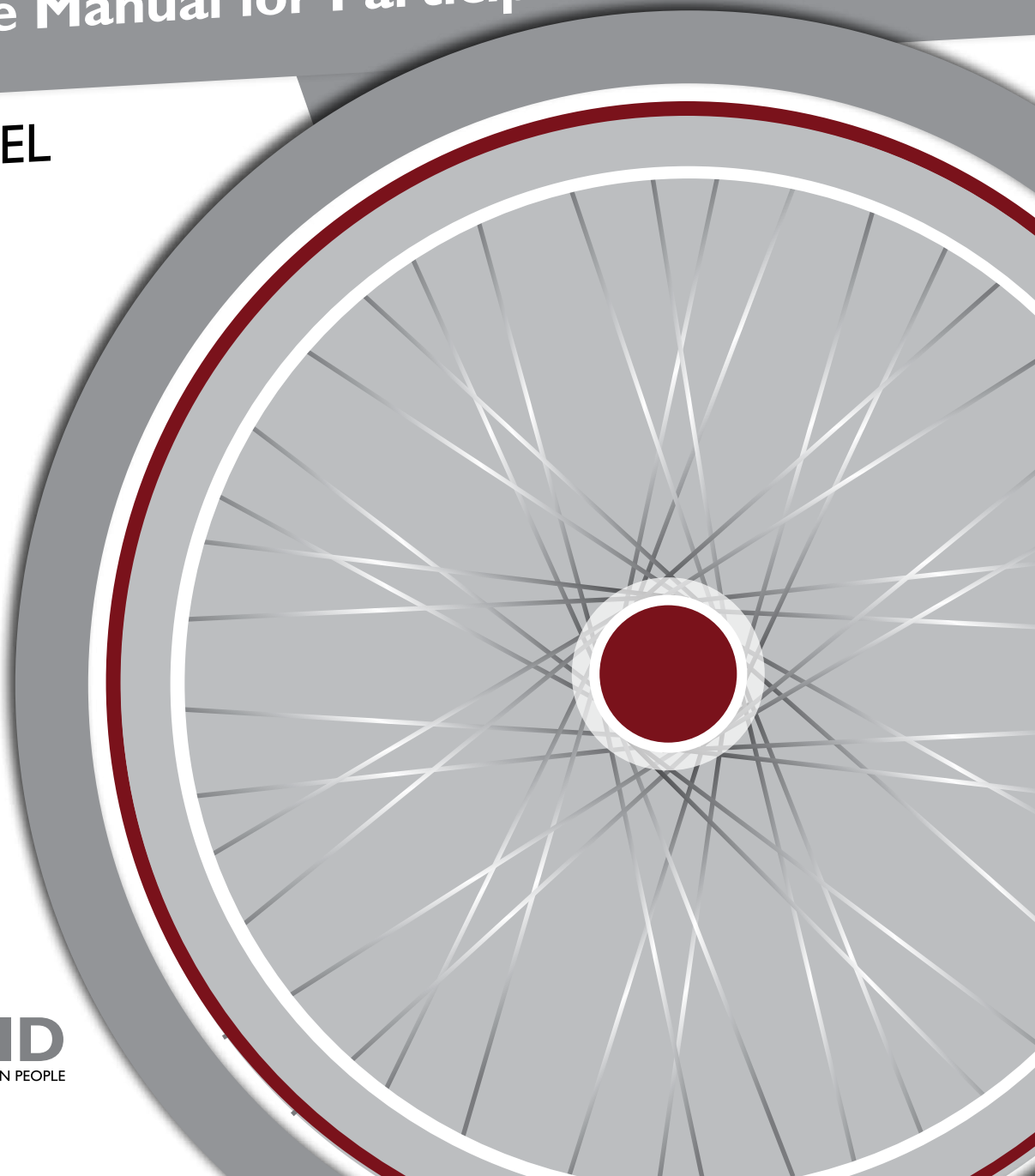

USAID
FROM THE AMERICAN PEOPLE

Contributors:

Editors:	Chapal Khasnabis and Kylie Mines
Authors:	Sarah Frost, Kylie Mines, Jamie Noon, Elsje Scheffler, and Rebecca Jackson Stoeckle
Peer reviewers:	Natasha Altin, Jo Armstrong, William Armstrong, Johan Borg, Jocelyn Campbell, Nelja Essaafi, Robert G. Horvath, Lauren Houppapa, Mohamed El Khadiri, R. Lee Kirby, Penny Knudson, Mark Kruizak, Bigboy Madzivanzira, Rob Mattingly, Cindy Mosher, Ritu Ghosh Moullick, Alana Officer, Andrew Rose, Allan Siekman, Sue Steel Smith, Michiel Steenbeek, Claude Tardif, and Isabelle Urseau
Illustrator:	Melissa Puust
Photo credits:	Chapal Khasnabis and Jesse Moss
Video credits:	Chapal Khasnabis, Amanda McBaine, and Jesse Moss
Pilot trainers:	Lauren Houppapa, Charles Kanyi, Norah Keitany, Seraphine Ongogo, M. Vennila Palanivelu Sama Raju, and Elsje Taloafiri
Financial support:	US Agency for International Development and Australian Agency for International Development
Partner organizations:	ASSERT East Timor, Association for the Physically Disabled of Kenya (APDK), Community Based Rehabilitation Unit of Solomon Islands Ministry of Health and Medical Services, Education Development Center (EDC), Handicap International, International Committee of the Red Cross (ICRC), International Society for Prosthetics and Orthotics (ISPO), Kilimanjaro Association of the Spinally Injured (KASI), Mobility India, Motivation Australia, Motivation Charitable Trust (Motivation), Motivation Romania, and Tanzania Training Centre for Orthopaedic Technologists (TATCOT)

WHO Library Cataloguing-in-Publication Data

Wheelchair service training package / edited by Chapal Khasnabis and Kylie Mines.

Contents: Trainer's manual, basic level—Reference manual for participants, basic level – Participant's workbook, basic level – Posters and slides, basic level.

Trainer's manual and slides available on DVD only.

1. Wheelchairs – standards. 2. Disabled persons – rehabilitation. 3. Teaching materials. I. Khasnabis, Chapal. II. Mines, Kylie. III. World Health Organization.

ISBN 978 92 4 150347 1 (package)

(NLM classification: WB 320)

ISBN 978 92 4 150348 8 (DVD)

© World Health Organization 2012

All rights reserved. Publications of the World Health Organization are available on the WHO web site (www.who.int) or can be purchased from WHO Press, World Health Organization, 20 Avenue Appia, 1211 Geneva 27, Switzerland (tel.: +41 22 791 3264; fax: +41 22 791 4857; e-mail: bookorders@who.int). Requests for permission to reproduce or translate WHO publications – whether for sale or for noncommercial distribution – should be addressed to WHO Press through the WHO web site (http://www.who.int/about/licensing/copyright_form/en/index.html).

The designations employed and the presentation of the material in this publication do not imply the expression of any opinion whatsoever on the part of the World Health Organization concerning the legal status of any country, territory, city or area or of its authorities, or concerning the delimitation of its frontiers or boundaries. Dotted lines on maps represent approximate border lines for which there may not yet be full agreement.

The mention of specific companies or of certain manufacturers' products does not imply that they are endorsed or recommended by the World Health Organization in preference to others of a similar nature that are not mentioned. Errors and omissions excepted, the names of proprietary products are distinguished by initial capital letters.

All reasonable precautions have been taken by the World Health Organization to verify the information contained in this publication. However, the published material is being distributed without warranty of any kind, either expressed or implied. The responsibility for the interpretation and use of the material lies with the reader. In no event shall the World Health Organization be liable for damages arising from its use.

Cover photo credits (clockwise, from top): Mile End Films / Jesse Moss; WHO / Chapal Khasnabis; Mile End Films / Jesse Moss; Panos / Dieter Telemans; WHO / Chapal Khasnabis.

Printed in Malta

Design by Inís Communication – www.iniscommunication.com

Terminology

The following terms used throughout the training package are defined below.

Appropriate wheelchair	A wheelchair that meets the user's needs and environmental conditions; provides proper fit and postural support and is safe and durable; is available in the country; and can be obtained and maintained and services sustained in the country at the most economical and affordable price.
Manual wheelchair	A wheelchair that is propelled by the user or pushed by another person.
Wheelchair	A device providing wheeled mobility and seating support for a person who has difficulty in walking or moving around.
Wheelchair provision	An overall term for wheelchair design, production, supply and service delivery.
Wheelchair service	That part of wheelchair provision concerned with ensuring that each user receives an appropriate wheelchair.
Wheelchair service personnel	Persons skilled in the provision of an appropriate wheelchair.
Wheelchair user	A person who has difficulty in walking or moving around and uses a wheelchair for mobility.

CONTENTS

VII	Preface
I	About the Wheelchair Service Training Package: Basic Level
5	A. Core knowledge
6	A.1: Wheelchair users
6	What are the benefits of a wheelchair?
7	What is an “appropriate wheelchair”?
7	The United Nations Convention on the Rights of Persons with Disabilities
8	A.2: Wheelchair services
10	A.3: Wheelchair mobility
13	A.4: Sitting upright
16	A.5: Pressure sores
21	A.6: Appropriate wheelchair
21	Meeting the wheelchair user’s needs
26	Meeting the wheelchair user’s environment
27	Providing proper fit and postural support
29	A.7: Cushions
34	A.8 Transfers
38	B. Wheelchair service steps
39	Step 1: Referral and appointment
41	Step 2: Assessment
50	Step 3: Prescription (selection)
52	Step 4: Funding and ordering
54	Step 5: Product (wheelchair) preparation
62	Step 6: Fitting
74	Step 7: User training
76	Step 8: Maintenance, repairs and follow up

Preface

The wheelchair is one of the most commonly used assistive devices for enhancing personal mobility, which is a precondition for enjoying human rights and living in dignity and assists people with disabilities to become more productive members of their communities. For many people, an appropriate, well designed and well fitted wheelchair can be the first step towards inclusion and participation in society.

The United Nations Standard Rules on the Equalization of Opportunities for Persons with Disabilities, the Convention on the Rights of Persons with Disabilities and World Health Assembly resolution WHA58.23, which deals with disability including prevention, management and rehabilitation, all emphasize the importance of wheelchairs and other assistive devices. To ensure that people with disabilities can access an appropriate wheelchair, especially in less resourced parts of the world, WHO developed the **Guidelines on the provision of manual wheelchairs in less resourced settings**, in partnership with the United States Agency for International Development (USAID) and the International Society for Prosthetics and Orthotics (ISPO).

In order to train human resources appropriately and provide a good wheelchair delivery system based on the Wheelchair guidelines, WHO has developed this **Wheelchair Service Training Package – Basic Level**.



Alana Officer

Coordinator
Disability and Rehabilitation Team
Department of Violence and
Injury Prevention and Disability
World Health Organization

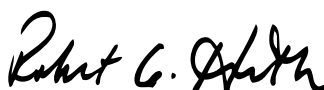

Robert G. Horvath

Manager
Programs for Vulnerable Populations
Center of Excellence on Democracy,
Human Rights, and Governance
US Agency for International Development

About the Wheelchair Service Training Package: Basic Level

Introduction

Following the release in 2008 of *Guidelines on the provision of manual wheelchairs in less resourced settings*,¹ the World Health Organization has developed the Wheelchair Service Training Package: Basic Level.

The wheelchair is one of the most commonly used assistive devices for enabling personal mobility. For people who have difficulties walking, a wheelchair which meets their physical, lifestyle and environmental needs is an essential tool, enabling them to enjoy vastly improved health, social and economic well-being. Mobility opens up opportunities for wheelchair users to study, work, engage in cultural activities and access services such as health care.

The importance of mobility is reflected in the United Nations Convention on the Rights of Persons with Disabilities (UNCRPD) which advocates for “effective measures to ensure personal mobility with the greatest possible independence for persons with disabilities”. To ensure effective personal mobility, wheelchair users need a wheelchair which fits them correctly and meets their specific needs. This requires an approach which is responsive to individual needs.

An effective way of meeting the individual needs of wheelchair users is the provision of wheelchairs through wheelchair services. However, statistics show that less than 5% of those in need actually have access to a properly fitted wheelchair. In addition, there are limited training opportunities for personnel to gain the skills needed to prescribe a wheelchair effectively.

The Wheelchair Service Training Package: Basic Level is intended to support the training of personnel fulfilling clinical and technical roles in a wheelchair service (see *Guidelines on the provision of manual wheelchairs in less resourced settings*, Table 4.2) at basic level. The training package supports the delivery of the theory and practice needed to begin working with wheelchair users who are able to sit upright without additional postural support. The training package includes: how to assess individual needs; assist in selecting and setting up the most appropriate wheelchair from those available; train users and caregivers how to use and maintain the wheelchair; and carry out follow up.

¹ World Health Organization. *Guidelines on the provision of manual wheelchairs in less resourced settings*. Geneva, 2008 (<http://www.who.int/disabilities/publications/technology/wheelchairguidelines/en/index.html>, accessed 15 December 2011).

The training package can be delivered in 35–40 hours, although this period may be extended or reduced according to the specific needs and resources available in each context. Further practice with a mentor is encouraged to build competencies and enhanced capacity for independent work.

WHO hopes to see the Wheelchair Service Training Package both delivered as a stand-alone short training programme for personnel already working in the field, and integrated into the curriculums of training programmes for rehabilitation personnel.

Target audience

This training package is for all personnel or volunteers who are expected to carry out wheelchair service delivery in their place of work. This may include health, rehabilitation or technical personnel, community health care workers, community-based rehabilitation workers, occupational therapists, physiotherapists, prosthetists, orthotists, local craftsmen, technicians and wheelchair users.

Purpose

The Basic Level training package is designed to support the training of personnel or volunteers to provide an appropriate manual wheelchair and cushion for girls, boys, women and men *who have mobility impairments but can sit upright without additional postural support*.

The main purpose of the training package is to develop the skills and knowledge of personnel involved in wheelchair service delivery. Delivery of this training package will help to:

- increase the number of wheelchair users who receive a wheelchair which meets their needs;
- increase the number of wheelchair users who receive training in the use and maintenance of wheelchairs and how to stay healthy in a wheelchair;
- increase the number of personnel trained in basic level wheelchair service delivery;
- improve the competencies of wheelchair service delivery personnel;
- increase the quality of wheelchair service delivery; and
- achieve greater integration of wheelchair service delivery within rehabilitation services.

Scope

The training package covers:

- an overview of the eight steps of wheelchair service delivery described in the *WHO guidelines on the provision of manual wheelchairs in less resourced settings (Table 1)*;

- working with wheelchair users to assess their mobility needs and identify the best possible mobility solution;
- providing an appropriate manual wheelchair with an appropriate cushion;
- problem solving to find simple modifications to the wheelchair that can help ensure the best fit for the user;
- wheelchair repairs and maintenance;
- training of wheelchair users to make the best use of their wheelchair; and
- fabrication of a foam contoured cushion.

The inclusion of simple wheelchair modifications is particularly relevant in contexts where there are limitations in the range and sizes of available manual wheelchairs. It is often necessary to make simple modifications to ensure a wheelchair fits correctly.

The provision of tricycles is not covered in detail in this training package, although the value of a tricycle for wheelchair users who need to travel longer distances is noted.

Table 1. Key steps of wheelchair service delivery:

Step 1	Referral and appointment
Step 2	Assessment
Step 3	Prescription (selection)
Step 4	Funding and ordering
Step 5	Product (wheelchair) preparation
Step 6	Fitting
Step 7	User training
Step 8	Maintenance, repairs and follow up

Required knowledge and skills

Previous experience in wheelchair service delivery is not required. However, the training programme has been designed assuming that participants will have the following knowledge and skills:

- participants will be able to read and write in the language of the training programme;
- participants will have a basic knowledge of the common health conditions; or physical impairments which may affect people who can benefit from wheelchairs, including cerebral palsy, lower-limb amputation, poliomyelitis (polio), spinal cord injury and stroke.

Where participants do not already have information about these health conditions or physical impairments, trainers should include this information as an additional core knowledge session.

Structure

The Wheelchair Service Training Package: Basic Level is designed to be delivered by trainers who are skilled in basic wheelchair service delivery and can confidently demonstrate the competencies taught in this training programme. There is a range of teaching resources, including:

- Trainer's Manual and trainer's tools;
- Reference Manual for Participants (hereafter referred to as Reference Manual);
- Participant's Workbook;
- Wheelchair service forms;
- Wheelchair service checklists;
- Visual aids, including PowerPoint slides, videos and posters.

Development process

Following the release of the *Guidelines on the provision of manual wheelchairs in less resourced settings*, WHO formed a working group to develop the Wheelchair Service Training Package. The first working group meeting was convened by WHO in October 2008 to determine the scope and content of the Training Package. Following circulation and receipt of feedback from over 20 experts in the field on the proposed Training Package content, a core group of contributors worked to prepare each training package for field piloting.

In 2010, the Basic Level training package was piloted in India, Solomon Islands and Kenya. Each pilot was observed by members of the WHO Wheelchair Training Package working group. Feedback from trainers, trainee participants and wheelchair users participating in the practical sessions has been incorporated into the final drafts. In addition to the pilots, the Basic Level training package was circulated for peer review, with valuable feedback gained from a range of experts in the field.

All the authors involved in the development of the training package completed a Declaration of Interest (DOI) and none declared any conflict of interest related to the subject matter.

A. Core knowledge



A.1: Wheelchair users

Wheelchair users are people who already have a wheelchair or who can benefit from using a wheelchair because their ability to walk is limited. Wheelchair users include:

- children, adults and the elderly; men, women, girls and boys;
- people with different mobility impairments, lifestyles, life roles and backgrounds;
- people living and working in different environments including rural, semi-urban and urban.

The needs of each wheelchair user will vary. However, they all need an **appropriate** wheelchair.

What are the benefits of a wheelchair?



- **Mobility:** Wheelchairs help people to get around with the greatest possible independence and do the things they want to do.
- **Health:** A wheelchair can improve the user's health in many ways. A well fitting wheelchair with a cushion can reduce common problems, such as pressure sores or poor posture. A wheelchair that works well, fits well and can be propelled easily can increase the physical activity of the user, thus improving health.
- **Independence:** Wheelchair users can be more independent and more in control of their own life.
- **Self-esteem and confidence:** Wheelchair users may become more confident and have more self-esteem when they have a wheelchair which fits them and which they can use well.
- **Access to community life:** With a wheelchair, wheelchair users can be more involved in community life. For example, it enables the user to go to work or school; visit friends; attend places of worship or other community activities.

What is an “appropriate wheelchair”?

An “Appropriate Wheelchair” is a wheelchair that:

- meets the user’s needs;
- meets the user’s environment;
- is the right match for the user;
- ensures postural support (helps the user to sit upright);
- can be maintained and repaired locally.

The United Nations Convention on the Rights of Persons with Disabilities

The *United Nations Convention on the Rights of Persons with Disabilities* (UNCRPD) entered into force on 3 May 2008.

There are human rights that apply to everybody. The UNCRPD focuses on ensuring that everybody recognizes that these rights also apply to people with disabilities. There are 50 different articles in the Convention.

One of the articles, article 20, is about “personal mobility”. Personal mobility means the ability to move in a manner and at the time of one’s own choice. Article 20 says: “States Parties shall take effective measures to ensure personal mobility with the greatest possible independence for persons with disabilities”.

Wheelchairs and wheelchair services are very important for assisting most people with mobility impairments to gain personal mobility. Wheelchair service personnel can help to implement article 20 of the UNCRPD by:

- providing an appropriate wheelchair for wheelchair users who visit their service;
- assisting wheelchair users in learning how to get in and out of their wheelchair themselves;
- supporting wheelchair users in learning how to propel themselves;
- encouraging family members to support wheelchair users to be as independent as they can be.

There are other human rights that people with mobility impairments can enjoy more easily if they have an appropriate wheelchair. These are:

- living independently and being included in the community (article 19);
- right to education (article 24);
- right to the enjoyment of the highest attainable standard of health (article 25);
- right to work and employment (article 27);
- right to participate in political and public life (article 29);
- right to participate in cultural life, recreation, leisure and sport (article 30).

The UNCRPD (Article 20–Personal mobility):

States Parties shall take effective measures to ensure personal mobility with the greatest possible independence for persons with disabilities, including by:

- a) Facilitating the personal mobility of persons with disabilities in the manner and at the time of their choice, and at affordable cost;
- b) Facilitating access by persons with disabilities to quality mobility aids, devices, assistive technologies and forms of live assistance and intermediaries, including by making them available at affordable cost;
- c) Providing training in mobility skills to persons with disabilities and to specialist staff working with persons with disabilities;
- d) Encouraging entities that produce mobility aids, devices and assistive technologies to take into account all aspects of mobility for persons with disabilities.

Which means:²

Countries should make sure disabled people can get about independently as much as possible. They should:

- Assist people get about.
- Assist people to get a quality wheelchair at an affordable cost.
- Give training on how to get about.
- Get entities/companies that make aids to think about all different needs of disabled people.





A.2: Wheelchair services

Wheelchair services work with wheelchair users to find the most suitable wheelchair among those available for that user. The WHO *Wheelchair guidelines* outline eight steps that wheelchair service personnel need to carry out to provide a wheelchair. These steps are summarized below. Each step is covered in more detail in Section B of this manual.

² International agreement on the rights of disabled people (easy-read version of the CRPD), prepared for the United Kingdom Department for Work and Pensions by the "easy read" service @ Inspired Services. ISI 64/07. Newmarket, Inspired Services, 2007 <http://odi.dwp.gov.uk/docs/wor/uncon/un-agree.pdf> (accessed 15 December 2011).



WHEELCHAIR

SERVICE TRAINING PACKAGE

Step	Summary	
1. Referral and appointment	<p>The way that wheelchair users are referred will vary. Users may refer themselves or be referred through networks made up of governmental or nongovernmental health and rehabilitation workers or volunteers working at community, district or regional level. Some wheelchair services may need to identify potential users actively if they are not already receiving any social or health care services or participating in school, work or community activities.</p>	
2. Assessment	<p>Each user needs an individual assessment, taking into account lifestyle, work, environment and physical condition.</p>	
3. Prescription (selection)	<p>Using the information from the assessment, a wheelchair prescription is developed together with the user and family members or caregivers. The prescription (selection) details the selected wheelchair type and size, special features and modifications. It also describes the training the user needs in order to use and maintain the wheelchair properly.</p>	
4. Funding and ordering	<p>A funding source is identified, and the wheelchair is ordered from stock held by the service or from the supplier.</p>	
5. Product (wheelchair) preparation	<p>Trained personnel prepare the wheelchair for the initial fitting. Depending on the available product and service facilities, this may include assembly, and possible modification, of products supplied by manufacturers or manufacture of products in the service workshop.</p>	

Continues..

Continued

Step	Summary	
6. Fitting	The user tries the wheelchair. Final adjustments are made to ensure the wheelchair is correctly assembled and set up. If modifications or postural support components are required, additional fittings may be necessary.	
7. User training	The user and caregivers are trained how to use and maintain the wheelchair safely and effectively.	
8. Maintenance, repairs and follow up	The wheelchair service provides maintenance and repair services for technical problems that cannot be solved in the community. It is appropriate to carry out follow up activities at the community level as much as possible. Follow up appointments are an opportunity to check wheelchair fit and provide further training and support. The timing depends on the needs of the user and the other services that are available to them. If the wheelchair is found to be no longer appropriate, a new wheelchair needs to be supplied starting again from step one.	

Source: World Health Organization. *Guidelines on the provision of manual wheelchairs in less resourced settings*, Table 3.2. Geneva, 2008:76.





A.3: Wheelchair mobility

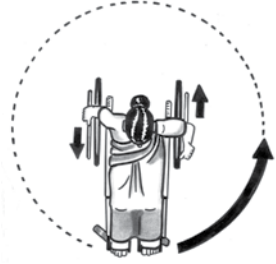

Many wheelchair users live and work in places where it is difficult for them to get around, for example areas where the ground is rough, sandy or muddy, or where there are steps, kerbs or small cramped spaces.

Training in wheelchair mobility skills can help wheelchair users to tackle some of these obstacles, either independently or with assistance.

Various wheelchair mobility skills are described below.

Wheelchair Mobility Skills:

Pushing		<ul style="list-style-type: none"> • Pushing correctly requires less effort. • Push from 10 o'clock to 2 o'clock position. • Use long smooth action to push.
Turning		<ul style="list-style-type: none"> • Hold one push rim towards the front and the other towards the back. • Pull the forwards hand backwards and push the backward hand forwards at the same time.
Up slopes		<ul style="list-style-type: none"> • Lean forward – this helps to stop the wheelchair tipping. • When practising, have an assistant stand behind for safety. • To stop or rest – park the wheelchair sideways on.
Down slopes		<ul style="list-style-type: none"> • Lean backwards. • Let the push rim slide slowly through the hands. • Experienced wheelchair users who are able to do a "wheelie" (i.e. balance the wheelchair on the rear wheels only) may roll down a slope on their back wheels. This is very efficient.
Up steps with assistance		<ul style="list-style-type: none"> • Go up backwards. • Tilt wheelchair on to back wheels, positioned against the first step. • Assistant pulls backwards and upwards – rolling the wheelchair up. • Wheelchair user can assist by pushing the push rim backwards. • A second assistant can assist by holding on to the wheelchair frame from the front (not footrests).

<p>Down steps with assistance</p>		<ul style="list-style-type: none"> • Go down forwards. • Tilt the wheelchair on to back wheels. • Assistant lets the back wheels roll down slowly, one step at a time. • Wheelchair user can assist by controlling the wheelchair with the push rims. • A second assistant can help by steadying the wheelchair from the front, holding on to the wheelchair frame (not footrests).
<p>Partial wheelie</p>		<ul style="list-style-type: none"> • Being able to do a partial wheelie is very useful for a wheelchair user. • The wheelchair user can lift the front wheels to clear small kerbs, stones and bumps. • Roll the wheelchair backwards until hands are in the 10 o'clock position. Then push forwards quickly. • The castor wheels should come up. • With practice, it is possible to lift the castor wheels at the right time to clear small obstacles. • Always make sure that there is an assistant standing behind the wheelchair user when he/she begins to practise this skill.

How to make wheelchair mobility skills training safe

- Do not stand on footrests when getting in and out of the wheelchair.
- Keep fingers clear of the wheel spokes and brakes.
- When learning how to go up hills, or doing a partial wheelie, ALWAYS have an assistant stand behind the person in the wheelchair.
- Do not assist a wheelchair user up and down steps unless you feel very sure that you are able to control the wheelchair safely. If unsure, get help.

A.4: Sitting upright

Most wheelchair users spend many hours sitting. This means that their wheelchair is not just a mobility aid. It also helps to support them in sitting upright comfortably.

Sitting upright/neutral sitting posture

What is posture?

Posture is the way a person's body parts are arranged. Wherever possible, a well fitting wheelchair should support wheelchair users in sitting in an upright posture. Sometimes "sitting upright" is described as a *neutral sitting posture*.

Why is it important to sit upright?

Sitting upright helps wheelchair users in many ways. Sitting upright is good for:

- **health:** an upright posture helps with digestion of food and breathing;
- **stability:** an upright posture is more stable;
- **weight distribution:** when sitting upright body weight is evenly distributed – this helps to reduce the risk of pressure sores;
- **comfort:** when body weight is distributed evenly, it is more comfortable for the user;
- **preventing problems with posture:** sitting upright will help to reduce the chance of developing deformities of the spine in the future;
- **self-esteem and confidence:** sitting upright can help wheelchair users feel better about themselves.

Even though sitting upright has many benefits, without postural support it can be hard to stay in this posture all day. This is why people without a disability use different postures throughout the day. For a wheelchair user who sits in a wheelchair all day, the wheelchair needs to provide enough support to help the user to sit upright comfortably.

How to tell if a person is sitting upright

Look from the side and check:

- ✓ Pelvis upright;
- ✓ Trunk upright, back following the three natural curves;
- ✓ Hips flexed near 90 degrees;
- ✓ Knees and ankles flexed near 90 degrees;
- ✓ Heels directly below the knees or slightly forward or back;
- ✓ Feet flat on the floor or footrests.



Look from the front and check:

- ✓ Pelvis level;
- ✓ Shoulders level, relaxed and arms free to move;
- ✓ Legs slightly open (abducted);
- ✓ Head upright and balanced over the body.



How the pelvis affects the way we sit

The pelvis is the base for sitting upright. To be strong and stable, a building needs a solid foundation. In the same way, to be stable when sitting the pelvis must be strong and stable.

When the wheelchair user is sitting upright, the pelvis is:

- level (viewed from the front); and
- upright or slightly tilted forward (viewed from the side).

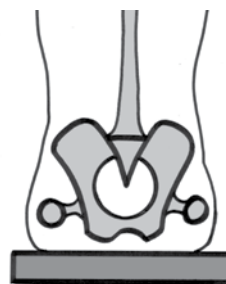

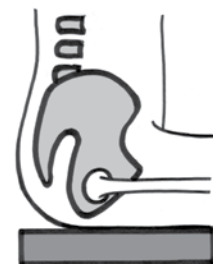

Front view of pelvis



Side view of pelvis

Any changes in the pelvis will cause a change in the other parts of the body. If the pelvis is not upright, it is difficult to sit upright.

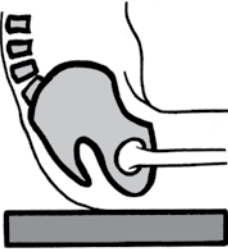
The pelvis moves in different ways. The table below shows four different pelvic movements and how the body changes when each movement is made.

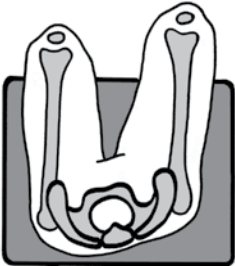
Movement	Illustration	Changes in the body
Rolling forward: (forward pelvic tilt).	 <p>Side view of pelvis</p>	<ul style="list-style-type: none"> • The body straightens out with the shoulders pulled back. • There is an increase in the curve of the spine above the pelvis.
Rolling backwards: (backward pelvic tilt).	 <p>Side view of pelvis</p>	<ul style="list-style-type: none"> • The body becomes rounded with the shoulders forward.
Tilting sideways: (lateral tilt).	 <p>Back view of pelvis</p>	<ul style="list-style-type: none"> • The body bends sideways.
Rotation.	 <p>View from above</p>	<ul style="list-style-type: none"> • The rest of the body also rotates.

A.5: Pressure sores

A pressure sore is an area of damaged skin and flesh. A pressure sore can develop in a few hours, but the results can last for many months and even cause death.

What causes pressure sores?

The three main causes of pressure sores are the following.



Pressure: Pressure sores can be caused by pressure on skin from sitting or lying in the same position for too long without moving.

Wheelchair users are particularly at risk, because they may spend a long time each day sitting in their wheelchair. Unless the pressure is relieved, a pressure sore can quickly develop.



Friction: Friction is constant rubbing on the skin. For example, an arm rubbing on a wheel/armrest as a wheelchair is moved can cause a pressure sore.



Shear: Shear is when the skin stays still and is stretched or pinched as muscles or bones move.

For example, when a wheelchair user sits “slumped” in the wheelchair, skin may be damaged by shear by the seat bones as the pelvis rocks backwards, or by bones in the back squeezing the skin against the backrest.

Pressure sore risk factors

As well as the three main causes of pressure sores, there are a number of things that make it more likely that someone will get a pressure sore. All these are called *pressure sore risk factors*.

Pressure sore risk factors include the following.

WHEELCHAIR

SERVICE TRAINING PACKAGE

- **Person cannot feel (decreased sensation):** Anyone who cannot feel, or has difficulty feeling touch on their buttocks (like most paraplegics or quadriplegics), seat or legs is at risk of developing a pressure sore.
- **Person cannot move:** When a person cannot move, he/she is unable to relieve the pressure.
- **Moisture from sweat, water or incontinence:** Moisture makes the skin soft and more easily damaged. If the user does not have a way to manage bladder and bowel function, urine and faeces can burn and damage the skin.
- **Poor posture:** Not sitting upright can cause an increase in pressure in one area.
- **Previous or current pressure sore.**
- **Poor diet and not drinking enough water:** A good diet, including drinking enough water, is important to ensure the body has fluid and nutrients to maintain healthy skin and heal wounds.
- **Ageing:** Elderly people often have thin, frail skin which can damage easily.
- **Weight (underweight or overweight):** People who are overweight may have poor blood flow in their skin, which can then damage easily and heal poorly. Wheelchair users who are underweight are at risk of developing a pressure sore because their bones are not well protected. The skin over the bony areas can be damaged quickly.

Common pressure sensitive areas:

Side view



Back view

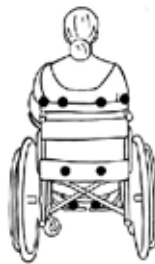

The four stages of a pressure sore ³		What to do
I	A red or dark mark on the person's skin. The redness or change in colour does not fade within 30 minutes after pressure is removed.	<ul style="list-style-type: none"> • Remove pressure from that area immediately. • Keep pressure off until the skin has fully healed. This may mean bed-rest. • Identify the cause and address this. • Teach the wheelchair user how pressure sores are formed and how to prevent them in future.

Continues..

³ Spinal Injury Network. Pressure sore stages (<http://www.spinal-injury.net/pressure-sore-stages-sci.htm>, accessed 13 December 2011).

Continued

The four stages of a pressure sore		What to do
2	A shallow wound. The top layer of skin may start to peel away or blister.	Follow the actions for stage 1. Refer for treatment of the pressure sore to an experienced health care worker.
3	A deep wound; the whole layer of skin is lost.	Open pressure sores will need cleaning, dressing and close monitoring to ensure they are healing and do not become infected. Stage 4 wounds may require surgery.
4	A very deep wound, extending through the muscle and possibly right down to the bone.	

How can pressure sores be prevented?

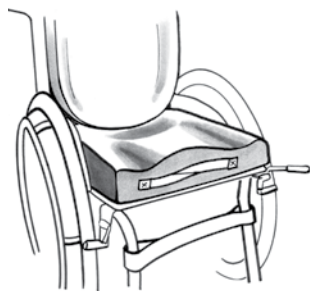

Use a pressure relief cushion: A pressure relief cushion will help to reduce pressure. Anyone at risk of developing a pressure sore should be given a pressure relief cushion.

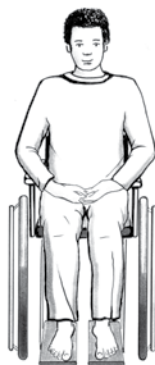

Sit upright: Sitting upright helps to distribute weight evenly. This reduces pressure under bony parts and helps to reduce sores caused by pressure. Sitting upright also helps to avoid pressure sores caused by shear.

Wheelchair service personnel can help wheelchair users to sit upright by making sure the wheelchair fits correctly and explaining why it is important to sit upright.



Use pressure relief techniques: Regular pressure relief can be effective in preventing pressure sores. See below for more information about how to relieve pressure.

WHEELCHAIR

SERVICE TRAINING PACKAGE



Eat well and drink lots of water: A well balanced diet with fresh vegetables, fruits and meat can help to prevent pressure sores.

Drinking lots of water will help to keep the skin healthy and prevent pressure sores.

If you are concerned about a wheelchair user's diet – consider referring him/her to a service that can help.

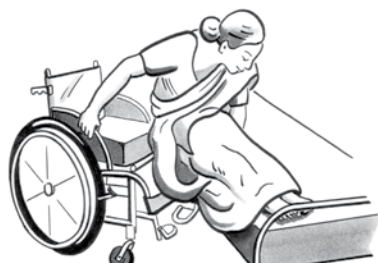

Avoid friction: Make sure the wheelchair fits correctly and has no rough edges.

Teach wheelchair users who cannot feel to check that no parts of their body are being rubbed by the wheelchair.

Teach wheelchair users to take care when getting in and out of the wheelchair.



Avoid moisture: Wheelchair users need to be advised to change wet or soiled clothing straight away, and not to use a wet cushion.

A bowel and bladder management programme can reduce problems with moisture. Refer wheelchair users who have a problem with incontinence to a service that can help them.

Check skin every day: Pressure sores can develop quickly. It is important to identify a pressure sore quickly and take action.

Encourage wheelchair users who are at risk to check their skin every day. They can check themselves using a mirror, or ask a family member to check.

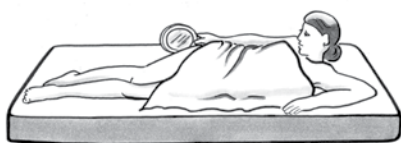

If they see a red or dark area of the skin (stage I pressure sore), they should take all necessary measures to relieve pressure on that spot immediately.

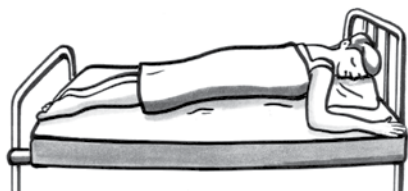

While lying or sitting, change positions regularly: Changing position regularly helps to relieve pressure. For example, change position from sitting to lying.

This is particularly important for someone who has a number of pressure sore risk factors, or has a recently healed pressure sore.

People who cannot change position by themselves are at risk.

Pressure relief techniques

Wheelchair users can relieve pressure from the seat bones while in their wheelchair. How they do this will vary, depending on how much strength and balance they have.

Wheelchair service personnel need to teach all wheelchair users who are at risk of developing a pressure sore at least one way to relieve pressure.

Bending forward:

A method suitable for most wheelchair users.

Independent: for people with good balance and strength.



With assistance: For people with poor balance and strength.



Side to side leaning:

A method suitable for wheelchair users with limited strength and balance.



Some wheelchair users may hook their arm over the push handle for support.



A.6: Appropriate wheelchair

Parts of a wheelchair

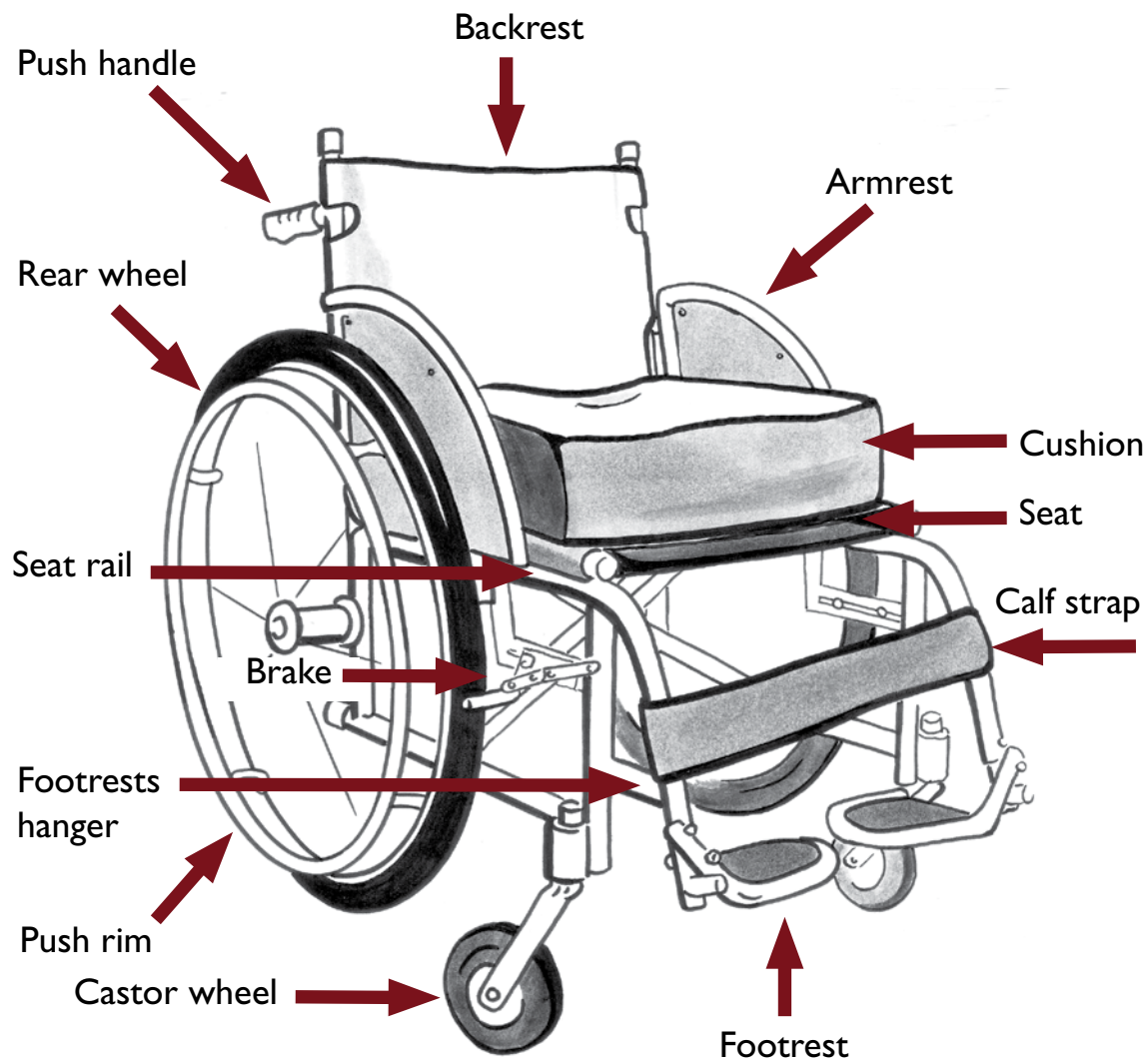

Definition of an “appropriate wheelchair”

Please refer to session A.1 Wheelchair users.

Meeting the wheelchair user’s needs

An appropriate wheelchair should make it easier for wheelchair users to carry out the things they need to do. Wheelchair users need to be able to get in and out of their wheelchair, to push their wheelchair, to fold the wheelchair for transport and storage and carry out their daily activities. The right type of wheelchair can make it easier for the wheelchair user to do all these things. See the examples below.

Transfers

Getting in and out of the wheelchair

Wheelchair users get in and out of the wheelchair in different ways, depending on their physical ability. Different wheelchair features can make their transfers easier. Three features that make transfers easier are: armrests, footrests, and brakes.

Removable armrests, or armrests which follow the line of the rear wheels, are easier for people who get in and out of their wheelchair sideways.

People who stand up to get in and out of the wheelchair may need armrests to help them stand up.



Footrests which can be moved out of the way are helpful for people who stand up to get in and out of the wheelchair.

People who want to transfer to the floor may prefer a wheelchair with removable footrests.



Brakes are important for all wheelchair users. They are essential for keeping the wheelchair still while the person gets in and out of the wheelchair.

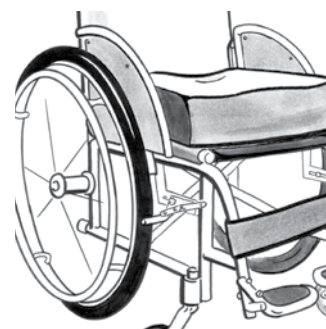

Pushing the wheelchair

Wheelchair users propel their wheelchair in different ways. Many wheelchair users propel the wheelchair with their arms. Some wheelchair users push the wheelchair with their feet – or with one arm and one foot. Some wheelchair users need someone to push the wheelchair for them some or all of the time.

Pushing the wheelchair by hand propelling is easier when the armrests and backrest are the right height.

WHEELCHAIR

SERVICE TRAINING PACKAGE



Backrest is too high. The wheelchair user cannot comfortably move the arms and shoulders to push.



Armrests are too high. The wheelchair user cannot comfortably reach the wheels to push.



When the backrest is lower, the wheelchair user has freedom to move the shoulders to push.

For a wheelchair user who can sit upright and has good balance, this is a good height for the backrest.

Pushing the wheelchair is easier if the wheelchair user can reach the push rims comfortably.

The rear wheel should be positioned so that when the wheelchair user holds the top of the push rim the elbow is bent at 90 degrees.



This is a good pushing position.

If the wheel is further back, it is more tiring for the wheelchair user to push.

Some wheelchairs have an adjustable rear wheel position. The position of the rear wheels affects how easy it is to push the wheelchair into a wheelie.

Wheelies are useful for going over rough ground, up and down kerbs or down slopes.



If the rear wheels move **forwards**, the wheelchair is easier to push into a wheelie.

If the rear wheels move **backwards**, they become more stable but the wheelchair is harder to push and it is harder to perform a wheelie.

Pushing the wheelchair with the feet is easier if the wheelchair user has enough power in one leg and can sit with the pelvis supported by the wheelchair backrest and the feet flat on the floor.



For wheelchair users who push with their feet, the height of the seat from the floor (including the cushion) is very important.

Footrests that swing out of the way are also essential.

Some users who push with their feet may like a tray or armrests so that they can lean forward while pushing.

A heavy wheelchair takes more energy to push – whether hands, feet or assistant-propelled.

However, if the wheelchair is well designed and well balanced, the weight may not be such a problem.



The weight of the wheelchair is particularly important in the case of children. If the wheelchair is heavy, this may make the chair hard for the child to control.



Folding the wheelchair

To transport or store the wheelchair, it needs to fold. Wheelchairs fold in two main ways.



Wheelchairs with a cross-folding frame fold so that both sides come together. Sometimes it is possible to remove the wheels as well.

Cross-folding wheelchairs can be helpful for wheelchair users needing to “squeeze” through narrow doorways.

For transport, some people prefer a cross-folding wheelchair. For example, it may fit better in the aisle of a bus.

A disadvantage with some cross-folding frames is that the folding mechanism can weaken, making the wheelchair feel unstable. It then becomes harder to push.

WHEELCHAIR

SERVICE TRAINING PACKAGE

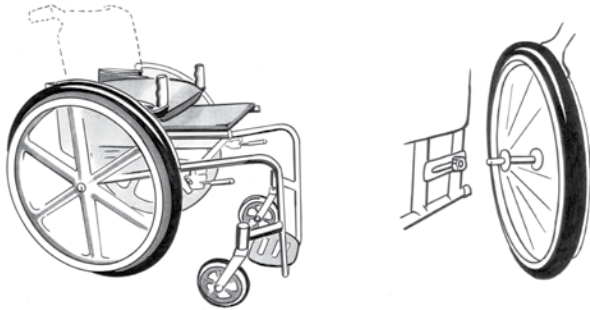

Some rigid frame wheelchairs also fold. However, instead of the two sides folding together, the backrest folds down and the rear wheels come off.

One advantage of rigid frames is that they can be more durable, as there are fewer moving parts.

Carrying out activities

There are several features of a wheelchair which affect how easily a wheelchair user can carry out the activities of daily life. For example, the features that help a wheelchair user to push (described above) will dictate how easily he/she can participate in activities. Here are some other examples.

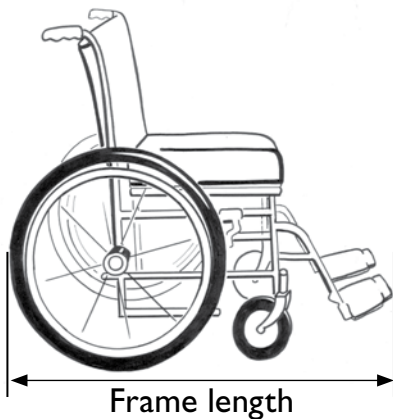

Wheelchair frame length: The overall length of a wheelchair can affect how easy or difficult it is to use in small spaces. For someone who spends a lot of time indoors, a wheelchair with a short length may be the best choice.

The frame length is measured from the furthest back part of the wheelchair to the furthest front part.

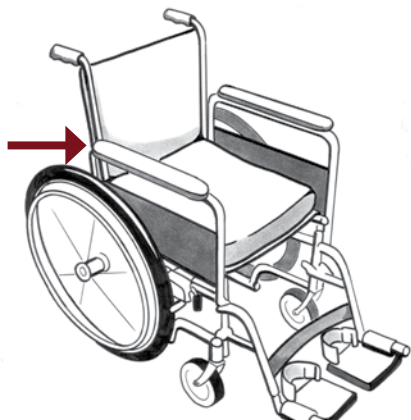

Armrests: High armrests may make it difficult for the user to get close to a table or desk.

Remember: An appropriate wheelchair helps to meet users' needs. This includes making it easier for them to do the things they need and want to do.

Meeting the wheelchair user's environment

Different types of wheelchair are suited to different environments. The main features which affect how a wheelchair works in a different environment are:

- distance between the front and rear wheels (wheelbase);
- the size and width of the wheels.

Distance between the front and rear wheels (wheelbase).



The distance between the front and rear wheels is important.

When the wheels are further apart, this is called a “long-wheelbase”. When the wheels are closer together, this is a “short-wheelbase”.

Long-wheelbase wheelchairs are more stable and less likely to tip forward. They can be a good choice for a person who will spend most of the time outdoors and moving over rough or uneven surfaces.

There are three-wheel and four-wheel long-wheelbase wheelchairs.



Three-wheel long-wheelbase wheelchairs are usually very stable and suitable for outdoors on rough terrain.



The four-wheel long-wheelbase wheelchairs have the front castor wheels under the footrests instead of behind. This gives the wheelchairs a longer wheelbase.

Shorter-wheelbase wheelchairs are more suited to use in places where the ground is flat or the space is confined – indoors, for example. Short-wheelbase wheelchairs are more likely to tip forward if going downhill, or if the front wheels hit a bump.

WHEELCHAIR

SERVICE TRAINING PACKAGE



This is an example of an orthopaedic-style wheelchair with a short wheelbase.

This chair would not be easy to push over rough terrain.



Wheelchair users with good mobility skills may use a short-wheelbase wheelchair outdoors by balancing on the back wheels to go down hills and over rough ground.

Size and width of wheels



The larger the wheel, the easier it is to push over uneven ground.

Wide rear wheels and large and wide front castors help prevent the wheelchair from sinking into sandy or muddy ground.

Remember: An appropriate wheelchair will suit the user's environment – which means the area where he/she spends most time.

Providing proper fit and postural support

All wheelchair users are different sizes. The wheelchair must fit the user correctly to provide proper fit and support. Fortunately, many wheelchairs come in a range of different sizes, or have size adjustments. It is easier to make sure these wheelchairs fit the user than if there is only one size available. The following components or features of a wheelchair will affect how well the wheelchair fits and how well it helps the user to sit upright.

Seats

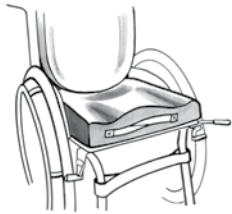

Seats: Wheelchair seats may be either solid or slung.

The picture on the left shows a solid seat. Solid seats may be made from wood or plastic. Solid seats should always have a cushion over the top.



Slung seats are usually made from canvas.

Slung seats are made from fabric attached to each side of the frame. Poor-quality slung seats can sometimes stretch and sag so they fail to provide good support. The man pictured on the left is sitting in a wheelchair with a slung seat which has become loose and saggy. It does not provide him with support. This makes it difficult for him to sit upright.

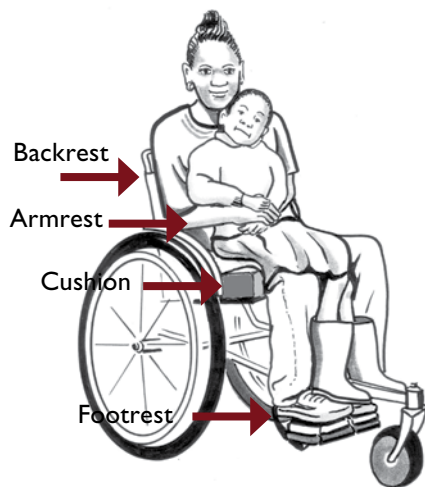

Backrests: Backrests may be slung or solid. All solid backrests should have some padding/cushioning.

Wheelchairs come with different backrest heights. Some wheelchairs have adjustable backrest heights. The correct backrest height needs to be selected for each user.

Armrests: Armrests can also provide support.

Some armrests are height-adjustable. If they are not, they can sometimes be modified to give more support for a user who needs it.

Cushions: The cushion provides comfort, helps to relieve pressure, and also provides support and helps to stop the user from sliding.

Footrests: Footrests help to support the user. It is very important that footrests are adjusted correctly. For this reason, the height of the footrests is usually adjustable.

Some footrests can also be adjusted by angle, and the distance away from the wheelchair.

Remember: An appropriate wheelchair provides proper fit and support for the user.

A.7: Cushions

What are cushions for?

A cushion is a very important part of every wheelchair. Cushions provide:

- comfort;
- posture support (help people to sit more upright);
- pressure relief.

All wheelchair users should be comfortable in their wheelchair, and a good cushion helps them to sit upright easily and comfortably. That is why every wheelchair user should have a cushion. It is not necessary for every wheelchair user to have a pressure relief cushion.

Different types of cushions

Cushions can be described in different ways, including:

- the material they are made from (for example foam, coir);
- the material they are filled with (for example air, fluid or gel);
- their main function (for example pressure relief, comfort, posture support);
- their shape (for example flat or contoured);
- how they are made (for example foam cushions may be “moulded” from one piece of foam or “layered” – made from a number of layers of foam).

The most commonly available cushion is a foam cushion. Foam cushions are also usually the least expensive. They are easy to make where foam is available and easy to modify to suit individual wheelchair users.

Who needs a cushion?



Every wheelchair user should have a cushion.

Wheelchair users at risk of developing a pressure sore should use a pressure relief cushion.

Pressure relief cushions

There are different types of pressure relief cushions including:

- foam contoured pressure relief cushions;
- air/fluid/gel filled cushions.

Foam pressure relief cushions

The key features of a foam pressure relief cushion are the following:

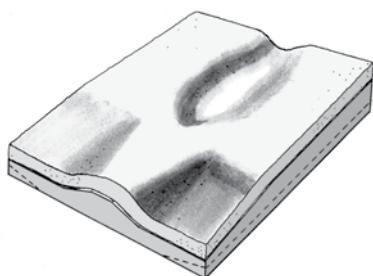

Firm stable base: The base of a pressure relief cushion should be firm. This will make sure the cushion provides good support for the user and does not move when the user moves.

Top layer: Over the base layer there should be a “comfort layer”. This is a layer (or more than one layer) of softer foam. The top layer should be soft enough to allow the seat bones to sink into it, but should not be so soft that the seat bones can sink all the way to the bottom and rest on the solid base or seat of the wheelchair.



Pressure relief cushions help to reduce pressure by:

- distributing a wheelchair user’s weight as evenly as possible across the seat surface;
- reducing pressure under high-pressure risk areas (seat bones, hip bones, coccyx/tail bone);
- reducing shear by assisting the wheelchair user to sit upright.

Shaping on a pressure relief cushion

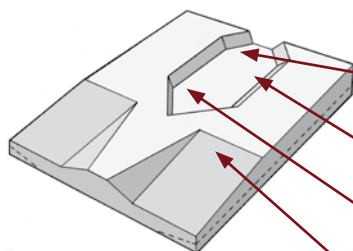

Pressure relief cushions vary. Shaping that you may see on a pressure relief cushion includes:

- a “well” under the seat bones to reduce pressure;
- support under the hip bones to help distribute weight;
- a shelf in front of the seat bones to keep the pelvis more upright and prevent sliding forward;
- grooves or gutters for the legs.

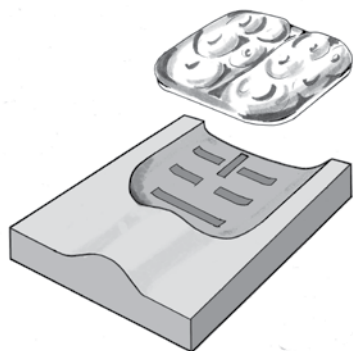
Air/fluid/gel pressure relief cushions

- Flotation cushions include those filled with air and those that have a fluid or gel pack.
- Gel-pack cushions should have a firm foam base very similar to a foam contoured cushion.
- Over the base layer there is a gel/fluid pack.
- The gel pack automatically matches the shape of the wheelchair user's body. This helps to distribute the user's weight evenly and reduces pressure under bony areas.

Which cushion to use?

There are advantages and disadvantages of both foam contoured cushions and air/fluid/gel cushions.

	Advantages	Disadvantages
Foam contoured cushion	<p>Can be made locally (where there is high-quality foam).</p> <p>Can be modified locally to accommodate different needs.</p> <p>Not subject to "sudden collapse" (a puncture in the air/fluid/gel cushions can cause the release of the materials from the cushion and stop the cushion from relieving pressure, causing "sudden collapse" of the cushion).</p> <p>The top layer of a layered foam cushion can be replaced easily and at a low cost (rather than replacing the whole cushion).</p>	<p>Foam compresses (becomes flatter and firmer) over time. For this reason, foam cushions should be checked regularly and replaced every 1–2 years.</p> <p>Can take a while to dry out (a problem for people who are incontinent).</p> <p>Foam insulates and can cause an increase in tissue temperature.</p>
Air/fluid/gel cushions	<p>Pressure is distributed evenly over the seat surface.</p> <p>The gel pad automatically adapts to the body when the wheelchair user moves or changes position.</p>	<p>Air/fluid/gel cushions are often more expensive and less readily available than foam cushions.</p> <p>Some wheelchair users find air/fluid/gel filled cushions make them feel unstable.</p> <p>Subject to "sudden collapse". In any context where a wheelchair user is not able to get a replacement cushion quickly, this can be a problem.</p>

Cushion covers

A pressure relief cushion should have a cover which can be removed for washing and is water-resistant. The material used for a pressure relief cushion cover should be either stretchy or loose enough to allow the seat bones to sink into the foam. If the cover fabric is not stretchy, a thin fabric is best. Folds in a thin fabric will be less likely to mark the skin and cause a pressure sore. If thin plastic is used under a fabric cover, this also needs to be loose enough to allow the seat bones to sink into the foam.

Always advise wheelchair users that if their cushion or cushion cover becomes wet it needs to be dried and replaced only when dry. For wheelchair users who are incontinent and at risk of developing a pressure sore, provide two cushions which may be used in turn.

What to do if there is no water-resistant cushion cover

Wherever possible, wheelchair users who are incontinent need a cushion cover which is water-resistant and will keep fluid away from the user's skin.

If there is no water-resistant cover:

- investigate what assistance can be provided to reduce incontinence;
- provide a second cushion – so that one can be drying while the user sits on the other;
- protect the cushion with a very thin plastic bag inside the cover.

If using a plastic bag:

- check that the plastic bag does not cause the user to “slide” on the cushion;
- make sure that there are no creases in the plastic bag that could cause a pressure sore;
- the wheelchair user must ensure that fluid does not “pool” over the plastic, as this increases the risk of a pressure sore;
- the wheelchair user should ensure that the cover is dried out if it becomes wet and the plastic bag cleaned or replaced.



How to test if a pressure relief cushion is working

Whenever you prescribe a pressure relief cushion, carry out this simple manual test to check whether the cushion is reducing pressure under the user's seat bones.

The test requires personnel to place their hands underneath the wheelchair user's seat bones. Always explain to the wheelchair user what you are going to do and why it is important.

Always carry out the test with the same cushion and the wheelchair that has been provided for the user.

Manual pressure test

A		<p>Explain to the wheelchair user what you are going to do, and why it is important.</p>
B		<p>Ask the wheelchair user to push up or lean forward to allow you to place your fingertips under their left or right seat bone (palm up).</p> <p>This is best done from behind the wheelchair by reaching under the back upholstery with one hand.</p>
C		<p>Ask the wheelchair user to sit back down on your fingers. They should sit normally, face forward, and place their hands on their thighs. This will ensure that they sit in the same position each time you move to check another location.</p> <p>If your fingers are not in a good position to feel the pressure under the seat bone, then ask the user to push up again and reposition your fingers.</p>
D	<p>Identify the pressure under the first seat bone as either level 1, 2, or 3:</p> <p>Level 1 = safe: Fingertips can wriggle up and down 5 mm or more.</p> <p>Level 2 = warning: Fingertips cannot wriggle, but can easily slide out.</p> <p>Level 3 = unsafe: Fingertips are squeezed firmly. It is difficult to slide fingers out.</p>	
E	<p>Repeat under the second seat bone.</p>	

How to reduce “warning” or “unsafe” pressure?

When level 2 (warning) or level 3 (unsafe) pressures are found under the seat bones, action is needed to reduce the pressure. A simple solution is to add an extra layer of firm foam. This is called a “lift”. The lift should be approximately 20 mm thick and have holes cut out under the seat bone area. The lift is placed underneath the cushion and inside the cover. Sometimes more than one layer is needed. Personnel should add one layer and test the pressure. If the pressure is still level 2 or 3, add another layer.

A.8 Transfers

Getting in and out of the wheelchair

The ability to get in and out of the wheelchair easily and safely, with or without assistance, will help a wheelchair user in daily life. Getting in and out of the wheelchair can be called “transferring”.

Why do wheelchair users need to learn how to transfer?

Wheelchair users may need to get in and out of their wheelchair several times a day. They need a method which is safe, quick and does not use much energy. Wheelchair users practise different methods, depending on their abilities.

Some wheelchair users can get in and out of the chair by themselves, and others need help. Some users can stand up to transfer, while for others this is not possible.

Three ways to get in and out of the wheelchair

Before recommending or practising a transfer with a wheelchair user you need to know whether he/she can transfer independently or needs help.

- For transferring independently through sitting, check that the wheelchair user can lift his/her weight upwards by pushing with the arms. If the user cannot do this, he/she needs help to transfer.
- For transferring independently through standing, check that the wheelchair user can stand up and take his/her own weight through the legs. If he/she cannot do this, he/she needs help to transfer.

Some different ways to transfer are shown below.

WHEELCHAIR

SERVICE TRAINING PACKAGE

Independent transfer through sitting (wheelchair to bed)



- Position the wheelchair close to the bed, apply brakes.
- Take feet off and swing away or remove (where applicable) the footrests.
- Remove armrest closest to the bed.
- Push up on hands and move to the front of the wheelchair.
- With one hand on the bed and the other on the wheelchair, push up and lift on to the bed.
- If the user has poor balance or cannot lift high enough or move sideways far enough, he/she may use a transfer board.

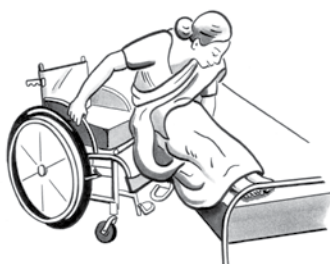

If transferring to a bed, some wheelchair users prefer to place their legs on to the bed before transferring.

Assisted transfer through sitting with a transfer board (wheelchair to bed)



- Position the wheelchair close to bed, apply brakes.
- Take feet off and swing away or remove (where applicable) the footrests.
- Remove armrest closest to the bed.
- Assist user to move forward.
- Put a transfer board under buttocks across the wheelchair and bed.
- User to assist as much as possible by pushing up on wheelchair and bed to take own weight.
- Assistant stands behind user, and moves user's buttocks over to the bed.

Assisted standing transfer (bed to wheelchair)



- Position the wheelchair, apply brakes.
- Take feet off and swing away or remove (where applicable) the footrests.
- Remove armrest closest to the bed.
- Assist the user to move forward on the bed and place feet on the floor.
- Support the user's knees from the side (do not push against knees from the front).
- Bring user's body forwards and upwards by supporting around the shoulder blades.
- Twist the user towards the wheelchair and allow him/her to sit down gently.

What is a transfer board?

A transfer board is a strong, thin board which can help to bridge the gap between the wheelchair and surface the wheelchair user is transferring to.

Transfer boards are useful for wheelchair users who are learning to transfer independently, or who have limited strength in their arms. The wheelchair user can carry out the transfer in a series of small lifts, rather than one big lift. A transfer board can also reduce the assistance a wheelchair user may need.

Transfer boards can be made locally from wood or plywood. They should be thin, strong and very smooth. Reduce the thickness at the edges. Suggested dimensions are 300 mm x 600 mm. The thickness of the board depends on the strength of the material, but a typical thickness is between 20 and 25 mm.

Independent transfer from floor to wheelchair

- This transfer requires the wheelchair user to have strong arms and good balance.
- Wheelchair users at risk of developing a pressure sore should always sit on their pressure relief cushion when sitting on the floor.

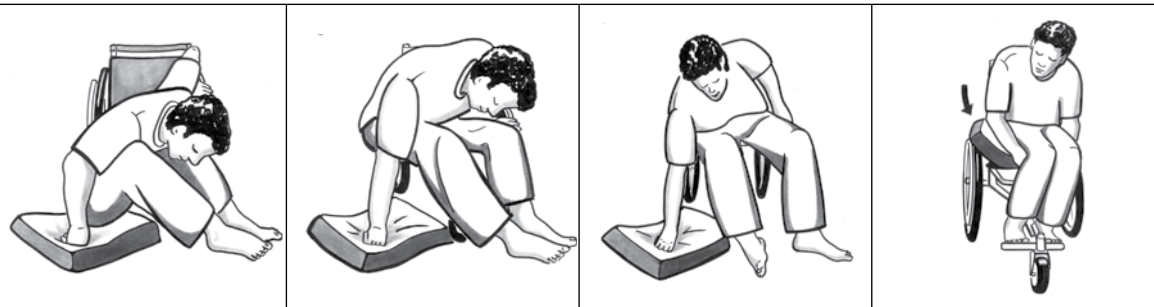

- Sitting in front of the wheelchair, draw the knees up close to the body.
- Look down and keep looking down throughout the lift.
- Place one hand on the floor and one hand on the front of the wheelchair seat.
- Push down with the shoulders and arms to lift buttocks up and on to the front of the wheelchair seat.
- Sit back into the wheelchair and reach down to pick up wheelchair cushion.
- Shifting your weight to one side, push the wheelchair cushion in place.

When transferring from the wheelchair to the floor

- Sit at the front of the wheelchair.
- Lift feet off the footrests in front of you and slightly to the side (away from the direction you are transferring).
- Place your cushion on the floor.
- With one hand on the wheelchair seat; reach down to the floor with the other hand.
- Using the shoulders and arms, move the buttocks down on to the cushion you have placed on the floor in a controlled movement.

How to make getting in and out of the wheelchair safe

For the wheelchair user:

- Always put the wheelchair brakes on when getting in and out of the wheelchair.
- Check where you are going – make sure there is nothing in the way.
- Always lift. Don't drag – this could cause skin damage and lead to a pressure sore.

For people assisting:

- Before assisting someone, make sure you can support his/her weight.
- Explain to the user what you are going to do.
- Use safe lifting techniques.
- Do not assist if you are pregnant or have a back problem.

B. Wheelchair service steps



Step I: Referral and appointment

Referral

Referral means: sending or directing a person to the right place for care or assistance.

There are different ways in which wheelchair users may be referred to a wheelchair service. For example, wheelchair users may:

- hear about the service and come themselves;
- be directed to the service by the local hospital, community health centre, community-based rehabilitation service, village/council/church leaders, disabled people's organizations, other wheelchair users.

Wheelchair services can help to increase the number of wheelchair users who are referred to the service by making sure that all possible referral sources know about the service.

Providing referral sources with a referral form can help to give the wheelchair service some simple initial information about the wheelchair user. Each wheelchair service needs to decide whether it will find a referral form useful, what information to include and how the form will be used (for example posted to the service, or handed to the wheelchair user to bring along).

A sample wheelchair referral form is shown on the next page.

Appointment

When a wheelchair user is referred to a wheelchair service, he/she should be given an appointment for an assessment, if he/she cannot be attended to on the same day. The appointment may be for the user to visit the service/centre, or for wheelchair service personnel to visit the user.

An appointment system helps wheelchair service personnel organize their time efficiently. It also means that wheelchair users do not have to wait around to see the service personnel.

The way an appointment is made depends on how easy it is to get a message to the wheelchair user. For example, messages may be sent by post, by phone or through the original referral source.

Sometimes, wheelchair users will arrive without an appointment. If possible, see them on the same day, especially if they have travelled a long way.

Good practice in appointment and referral

- Start a file for each wheelchair user when he/she is referred to the service.
- Educate referral sources about the wheelchair service and how to refer to the service.
- Give referral sources a supply of wheelchair referral forms.
- Where there are many wheelchair users, services should work out a way to decide who will be seen first. Consider particularly the needs of children and people with life-threatening conditions, such as pressure sores.

Wheelchair referral form

Please complete referral form and post to:

Wheelchair Service Name and Address:

A referral form should have clear contact details for the service including service name, postal address and telephone.

Name of referral person: _____

Organization you work for: _____

Referral person contact details (the best way to contact you):

Wheelchair user's name: _____ Date of Birth: _____

Parent / carer's name: _____

Address: _____

In this referral form the service will contact the wheelchair user to make an appointment. This may not always be possible. In this case, the service may accept referrals without appointment.

How can the wheelchair user be contacted? _____

Post Own Telephone Friend / neighbour's telephone _____

If by telephone, what is their phone number: _____

Wheelchair user's disability if known: _____

Reason for referral: _____

- Has no wheelchair
- Has a broken wheelchair
- Has a wheelchair that does not meet their needs

Please add any other information about the wheelchair user that you think it is important the wheelchair service knows:

The person referring should explain to the wheelchair user what the wheelchair service does. The wheelchair user should agree to a referral being made.

Has the wheelchair user agreed to being referred to the wheelchair service? Yes No

Signature of referring person: _____

Date: _____

Step 2: Assessment

Who needs a wheelchair?

When someone comes to a wheelchair service for a wheelchair, it is important to be sure that a wheelchair is really what they need. A person usually needs a wheelchair if:

- they cannot walk;
- they can walk, but with difficulty or only for a short distance.

Why do you need an assessment?

A wheelchair assessment is a chance to gather information to help:

- to help choose the most appropriate wheelchair for the wheelchair user from those available;
- to help choose the most appropriate wheelchair components from those available;
- find out what training the wheelchair user and/or the family need to make the best use of the wheelchair.

Where to carry out an assessment

Assessments should always be carried out in a clean, quiet space.

This may be a space within the wheelchair service, at another health care or community facility, or at the user's home.

If it is necessary to check whether a person has a pressure sore – do this in a private space.

Respect the dignity and privacy of the wheelchair user irrespective of his/her age, gender, religion or socioeconomic status.

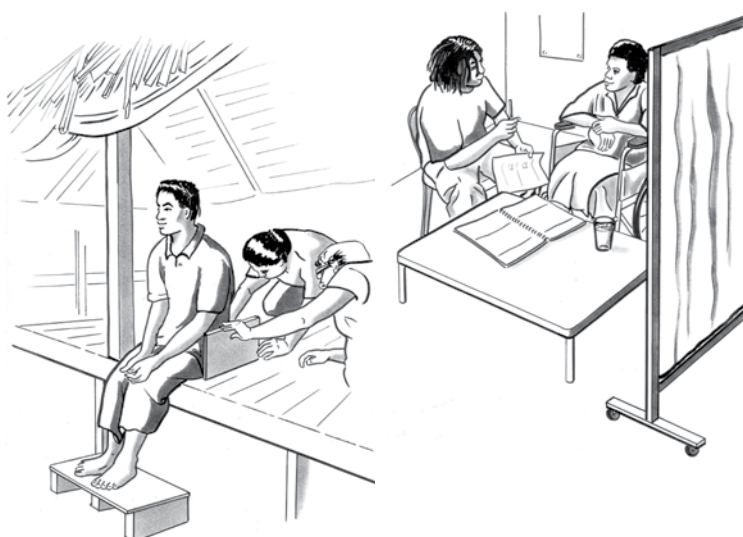

Two parts of an assessment:

- assessment interview;
- physical assessment.

I. Assessment interview

The best way to gather information about a wheelchair user is to ask questions. The wheelchair assessment form guides wheelchair service personnel to ask the most important questions for a wheelchair assessment.

There are four different question headings. These are:

- information about the wheelchair user;
- physical condition;
- lifestyle and environment;
- existing wheelchair.

Information about the wheelchair user:

Name: _____

Number: _____ Age: _____ Male Female

Phone no.: _____ Address: _____

Goals: _____

These questions are important so that the wheelchair user can be contacted for the follow up in the future. They also give statistical information about the users seen by the service.

Under “goals” write why the wheelchair user wants a wheelchair, and what he/she wants to be able to do in the wheelchair.

When asking questions remember:

- always explain to the wheelchair user why this information is important;
- always address the wheelchair user (not their assistant/family member) unless you are dealing with a small child or someone unable to understand or answer your questions;
- remember to use good communication methods;
- information may not always come in the same order as it appears on the form – make yourself familiar with the form so that the information can be recorded in the correct place.

Physical condition:

These questions are important because some of the features of health conditions can affect the choice of a wheelchair. Some examples are given below.

Physical condition

Cerebral palsy Polio Spinal cord injury Stroke

Frail Spasms or uncontrolled movements

Amputation: R above knee R below knee L above knee L below knee





Bladder problems Bowel problems

If the wheelchair user has bladder or bowel problems, are these managed?

Yes No

Others: _____

Different conditions affecting the wheelchair prescription (selection):



	What you need to know	Always remember
<p>Cerebral palsy</p> 	<p>Cerebral palsy affects people very differently.</p> <p>For a person with cerebral palsy who can sit upright, it is important to remember that they may have difficulty keeping their sitting position because they get tired. This makes doing things harder and more tiring.</p>	<p>Good support is very important.</p> <p>People with cerebral palsy may need additional postural support in a wheelchair. To do this safely and effectively, intermediate-level training is needed.</p>
<p>Poliomyelitis</p> 	<p>People who have poliomyelitis may have weakness or “floppiness” of body parts. Poliomyelitis can affect legs, arms or trunk, but most commonly affects the legs.</p> <p>The muscles and bones become thinner and the limb does not grow so fast and so is shorter.</p> <p>When the trunk is affected, it may appear shorter.</p>	<p>Although people with poliomyelitis have sensation, a cushion is important for comfort.</p> <p>A higher cushion may provide a more comfortable pushing position.</p>
<p>Spinal cord injury</p> 	<p>People with a spinal cord injury are very likely to be at risk of developing a pressure sore.</p> <p>This is because most people with a spinal cord injury cannot feel below the level of their injury.</p>	<p>Always prescribe a pressure relief cushion.</p>
<p>Stroke</p> 	<p>People who have had a stroke are usually affected on one side of their body. This means they may fall to one side in the wheelchair.</p> <p>People who have had a stroke may not be able to feel normally on the affected side of their body.</p> <p>People who have had a stroke may be able to get in and out of the wheelchair by standing up.</p>	<p>Good support is important.</p> <p>Check if the person can feel – he/she may need a pressure relief cushion.</p> <p>A person with a stroke may prefer a wheelchair with footrests which move out of the way so that he/she can do a standing transfer.</p>

Continues..

WHEELCHAIR

SERVICE TRAINING PACKAGE

Continued

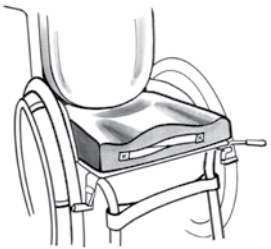
	What you need to know	Always remember
<p>Lower limb amputation</p> 	<p>People who are double amputees do not have the weight of their legs to stop their wheelchair from tipping backwards.</p>	<p>Always be careful when an amputee first tries a wheelchair.</p> <p>Check the wheelchair balance. The rear wheel may need to move backwards to provide extra stability.</p>
<p>Frail</p> 	<p>Elderly people may need a wheelchair for different reasons. Usually it is because they are having difficulty walking. The wheelchair will make it easier for them to continue to be a part of family and community life.</p> <p>Elderly people may be able to do a standing transfer, and will prefer a wheelchair with flip-up or swing-away footrests.</p>	<p>Elderly people should always be given a wheelchair which provides good comfort and support. This will help them to sit well and avoid problems caused by poor posture.</p> <p>Flip-up or swing-away footrests may be the best choice.</p>
<p>Spasms or jerky movements</p> 	<p>Some people have problems with sudden jerking, jumping movements that they cannot control (spasms).</p> <p>These can throw their weight backwards, making it more likely for the wheelchair to tip backwards.</p> <p>The movements can cause the feet to “jump” suddenly off the footrests. This can be dangerous when propelling.</p>	<p>Select a safe back wheel position or a very stable wheelchair.</p> <p>Straps may help control the foot position.</p> <p>Note: whenever straps are used, it is important that Velcro is used so that the strap can release if the user falls out of the wheelchair.</p>
<p>Bowel or bladder problems</p> 	<p>Some people cannot control their bladder or bowels.</p> <p>This problem can often be solved with the right equipment (catheters, for example), medication and a bladder and bowel training programme.</p> <p>People with bladder or bowel problems must not sit on a damp or soiled cushion, as their skin can rapidly break down. In addition, the bugs present in faeces rapidly lead to infected pressure sores.</p>	<p>Identify who in your area (for example specialist doctors and nurses) can offer advice and training to avoid these complications.</p> <p>Provide a cushion with a waterproof cover.</p> <p>Teach the user how to wash and dry the cushion.</p> <p>A second cushion may help to enable the user to continue day-to-day activities while the cushion dries.</p>

Lifestyle and environment:

These questions gather information about where the wheelchair user lives and the things that he/she needs to do in the wheelchair.

Lifestyle and environment

Describe where the wheelchair user will use their wheelchair:

Distance travelled per day: Up to 1 km 1–5 km More than 5 km

Hours per day using wheelchair? Less than 1 1–3 3–5 5–8 more than 8 hours

When out of the wheelchair, where does the user sit or lie down and how (posture and the surface)? _____

Transfer: Independent Assisted Standing Non-standing Lifted Other

Type of toilet (if transferring to a toilet): Squat Western Adapted

Does the wheelchair user often use public/private transport? Yes No

If yes, then what kind: Car Taxi Bus Other _____

Existing wheelchair:

These questions help to find out if the wheelchair user's existing wheelchair is meeting his/her needs, and if not, why not.

Existing wheelchair (if a person already has a wheelchair)

Does the wheelchair meet the user's needs? Yes No

Does the wheelchair meet the user's environmental conditions? Yes No

Does the wheelchair provide proper fit and postural support? Yes No

Is the wheelchair safe and durable? (Consider whether there is a cushion) Yes No

Does the cushion provide proper pressure relief (if user has pressure sore risk)? Yes No

Comments: _____

If yes to all questions, the user may not need a new wheelchair. If no to any of these questions, the user needs a different wheelchair or cushion; or the existing wheelchair or cushion needs repair or modifications

2. Physical assessment

There are three different question headings. These are:

- presence, risk or history of pressure sores;
- method of pushing;
- taking measurements.

Presence, risk or history of pressure sores

/// = does not feel ○ = previous pressure sore
● = existing pressure sore

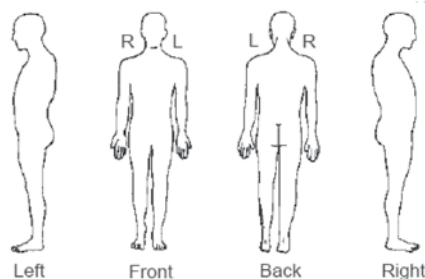

Can feel normally? Yes No

Previous pressure sore? Yes No

Current pressure sore? Yes No

If yes, is it an open sore (stage 1–4)? Yes No

Duration and cause: _____

Is this person **at risk*** of a pressure sore? *A person who cannot feel or has 3 or more risk factors is at risk. Risk factors: cannot move, moisture, poor posture, previous/current pressure sore, poor diet, ageing, under- or over-weight. Yes No

Mark on the body diagram:

- areas where the wheelchair user cannot feel; like this: ///
- areas where the wheelchair user has had a pressure sore in the past; like this: ○
- areas where the wheelchair user has a current pressure sore; like this: ●

If a wheelchair user says he/she has a pressure sore, always ask to see it. Make sure this is done in a private area.

A wheelchair user is at risk of developing a pressure sore if he/she cannot feel or has other risk factors.

The risk factors include:

- person cannot feel (decreased sensation);
- person cannot move;
- moisture from sweat, water or incontinence;
- poor posture;
- previous or current pressure sore;
- poor diet and not drinking enough water;
- ageing;
- weight (underweight or overweight).

Remember: Any wheelchair user at risk of developing a pressure sore needs a pressure relief cushion and education on preventing pressure sores.

Method of pushing

How will the wheelchair user push their wheelchair? Both arms Left arm
 Right arm Both legs Left leg Right leg Pushed by a helper

Comment: _____

It is important to find out how the wheelchair user will push, as this can affect the choice of wheelchair and the way it is set up (please refer to session A.6: Appropriate wheelchair, section "Pushing the wheelchair").

Taking measurements

Four measurements from the wheelchair user are needed to choose the best available size of wheelchair for that person. Each measurement relates to the wheelchair.

	Body Measurement	Measurement (mm)	Change body measurement to ideal wheelchair size	Wheelchair measurement (mm)
A	Hip width		Hip width = seat width	
B	Seat depth	L	B less 30–60 mm = seat depth (if length is different, use shorter one)	
		R		
C	Calf length	L	= top of seat cushion* to footrests height or = top of seat cushion* to floor for foot propelling	
		R		
D	Bottom of rib cage		= top of seat cushion* to top of backrest	
E	Bottom of shoulder blade		(measure D or E – depending on the user's need)	

*check the height of the cushion that the wheelchair user will use.

Measuring tools

- Use a retractable metal tape measure (pictured on the right).
- Clipboards/books can be used to help measure accurately (see How to take body measurements).
- Large callipers are an additional tool that can be very useful. These can be made locally from wood.
- Foot-blocks can be used to support the wheelchair user's feet at the correct height.



How to take body measurements



Ask the wheelchair user to sit as upright as possible.

The wheelchair user's feet should be supported on the floor or on foot-blocks if they cannot reach the floor comfortably.

For all measurements, make sure the tape measure is held straight and the wheelchair user is sitting upright. Holding a clipboard/book on either side of the wheelchair user can help in obtaining an accurate measurement.

Bend down to ensure you are viewing the tape measure at the correct angle.

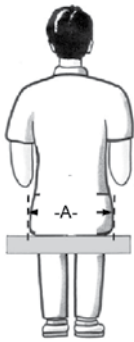

A	<ul style="list-style-type: none"> • Check there is nothing in wheelchair user's pockets before measuring. • Measure hips or widest part of thighs. • Holding two clipboards/books against each side of the wheelchair user can help in obtaining an accurate measurement.
B	<ul style="list-style-type: none"> • Place a clipboard/book at the back of the wheelchair user to help get an accurate measurement. • Measure from the back of the pelvis to the back of the knee in a straight line. • Always measure both legs. If there is a difference between the two legs, check that the wheelchair user is sitting up with the pelvis level. If there is still a difference, make the wheelchair prescription for the shorter side.
C	<ul style="list-style-type: none"> • Measure from the back of the knee to the base of the heel. • Make sure the wheelchair user's ankles are bent at 90 degrees (if possible). • Always measure both legs. • The wheelchair user should wear the shoes he/she wears most days (if any).
D	<ul style="list-style-type: none"> • Measure the seat to the bottom of the rib cage. • To help find the bottom of the rib cage, place hands on both sides of the pelvis. Gently squeeze hands inwards and slide hands upwards. The bottom of the rib cage is just above the waist.
E	<ul style="list-style-type: none"> • Measure from the seat to the bottom of the shoulder blade in a vertical line. • To help find the bottom of the shoulder blade, ask the user to shrug his/her shoulders.

For more information on the correct fit of a wheelchair, see step 6 session: Fitting.

Step 3: Prescription (selection)

What is prescription (selection)?

Prescription (selection) means selecting the best match possible between the wheelchairs available and the needs of the user.

The prescription (selection) should always be decided with the wheelchair user, including the family member or caregiver if appropriate.

Prescription (selection) includes:

- selecting the right wheelchair, cushion and wheelchair parts;
- selecting the right wheelchair and cushion size;
- agreeing with the wheelchair user what training they need to help them use and care for their wheelchair and cushion.

Locally available wheelchairs and cushions

Selecting the right size wheelchair is very important. The correct size wheelchair is more comfortable, helps to support upright sitting and is easier for the wheelchair user to use. For more information on the correct fit of a wheelchair, see step 6 session: Fitting.

- Frame – for example, whether it is a long or short wheelbase; the frame length; whether it is a cross-folding or rigid frame.
- Features – including the type of seat, backrest, footrests, armrests, castor wheels, rear wheels.
- Wheelchair size: This is usually described by the wheelchair seat width and sometimes also the depth. The seat height from the floor is also useful to know.
- Adjustability options: Which components are adjustable and what is the range of adjustment? Adjustment is usually possible to two or more different positions. For example, most wheelchairs have footrests which can be adjusted to different heights spaced evenly apart. The “range” of adjustment is from the smallest to the largest measurement.
- Cushion: What type of cushion (if any) is provided with the wheelchair or is available separately?

Some wheelchair suppliers provide:

- a. brochures or a product summary;
- b. product (wheelchair) specifications.

Wheelchair measurements, weights, features and sometimes optional parts are often listed in this information.

Always check whether there is information available about the wheelchairs you are prescribing. Read this information so that you are familiar with the products.

If suppliers do not give this information – ask for it.

Recording the prescription (selection)

The prescription (selection) needs to be written down. Below is an example of a wheelchair prescription (selection) form. Adapt this form for your local service by listing the types of wheelchairs and cushions available in your service and in what sizes.

Wheelchair Prescription (selection) Form

1. Wheelchair user information

Wheelchair user's name: _____ Number: _____

Date of assessment: _____ Date of fitting: _____

Assessor's name: _____

2. Type of wheelchair and size selected

select the type of wheelchair:

- Discuss with the wheelchair user;
- Think about the most important needs of the wheelchair user;
- Check: wheelchair frame, castor and rear wheels, footrests, armrests, backrest height (or adjustability), rear wheels position, support and comfort.

Type of wheelchair		Size
	<input type="checkbox"/>	
	<input type="checkbox"/>	
	<input type="checkbox"/>	
List the types of wheelchairs available in your service.	<input type="checkbox"/>	
	<input type="checkbox"/>	

List the types of cushions available in your service and their sizes.

3. Type of cushion selected

Type of cushion		Size
e.g. Foam pressure relief cushion	<input type="checkbox"/>	
e.g. Flat foam cushion	<input type="checkbox"/>	
	<input type="checkbox"/>	

4. Agreed with the selection

Signature of the user: _____

Signature of the assessor: _____

Signature of the manager: _____

Step 4: Funding and ordering

Funding

When the wheelchair has been prescribed, the cost of the recommended product can be accurately estimated. It is essential to know who will fund the wheelchair – it could be funded by an out-of-pocket payment, a subsidy from a government, nongovernmental organization or donor agency, or a payment by an insurance company. In the developing world, many people who need a wheelchair cannot afford to buy one. Nevertheless, everyone who needs a wheelchair is entitled to one, regardless of his/her ability to pay. Thus, funds will need to be made available for users who need financial assistance. For most services, it will be essential to identify the funding source before the wheelchair can be ordered.

Often, this responsibility lies with administrative personnel or programme managers rather than clinical or technical personnel.

Ordering

When the best wheelchair for the wheelchair user has been selected and the prescription (selection) form prepared, the wheelchair needs to be ordered, if not available within the existing stock.

If a wheelchair service keeps wheelchairs in stock, this may mean completing an order form to be authorized by the service manager. The wheelchair may then be prepared by the staff responsible for wheelchair preparation.

If the wheelchair service does not keep wheelchairs in stock, this may mean ordering from an external supplier.

The system for ordering wheelchairs will vary in different wheelchair services. Write down below the things that you need to remember to order wheelchairs in your local wheelchair service.

How to order wheelchairs in my local wheelchair service:

Good practice in ordering

- Keeping wheelchairs in stock can reduce waiting time for wheelchair users.
- An order should always be placed as quickly as possible to avoid delays.
- Always let the wheelchair user know when the wheelchair is likely to be available.

Step 5: Product (wheelchair) preparation

What is product (wheelchair) preparation?

Product (wheelchair) preparation includes:

- preparing the wheelchair to match the wheelchair user's prescription (selection);
- checking the wheelchair to make sure that it is safe and ready to be used and all parts are working properly.

Preparing the wheelchair

Prepare the wheelchair in the following order:

1. Check that the wheelchair seat width and depth measurements are correct for the prescription (selection).
2. Check that the cushion width and depth match the seat.
3. Adjust (where possible):
 - Backrest height and angle;
 - Armrests height;
 - Rear wheels position;
 - Brakes position;
 - Footrests height;
 - Push handles height;
 - Any other adjustments.
4. Carry out a "wheelchair safe and ready" check.

Good practice in product preparation

- Label each wheelchair being prepared with the wheelchair user's name.
- Any modifications to a wheelchair should always be carried out by someone with the appropriate knowledge and skills. Modifications can affect the strength and function of a wheelchair.
- Always check that the wheelchair is safe and ready to be used and that all parts are working before the wheelchair user tries it (see below).

Wheelchair safe and ready checklist

Use the checklist below to make sure that the wheelchair is safe to use and all parts are working. Always do this before the wheelchair user tries the wheelchair.

Checklist: Is the wheelchair safe and ready to use?

For the whole wheelchair		How to check
There are no sharp edges.	<input type="checkbox"/>	Check all over the wheelchair with eyes and hands.
No parts are damaged or scratched.	<input type="checkbox"/>	
The wheelchair travels in a straight line.	<input type="checkbox"/>	Push the wheelchair away from you, making sure the castor wheels are in the "trail" position.
Front castor wheels		
Spin freely.	<input type="checkbox"/>	Tip the wheelchair on to the back wheels. Spin the castor wheels.
Spin without touching the fork.	<input type="checkbox"/>	
Bolts are tight.	<input type="checkbox"/>	Check. They should feel firm. Do not over tighten.
Front castor barrels		
Castor fork spins freely.	<input type="checkbox"/>	Tip the wheelchair on to the back wheels. Spin the castor fork around.
Rear wheels		
Spin freely.	<input type="checkbox"/>	Tip the wheelchair sideways on to one rear wheel. Spin the other wheel. Check the other side.
Axle bolts are tight.	<input type="checkbox"/>	Check. They should feel firm. Do not over tighten.
Tyres (if those are pneumatic) are inflated correctly.	<input type="checkbox"/>	Press on the tyres with your thumb. The wheel should depress a little, but no more than 5 mm.
Push rims are secure.	<input type="checkbox"/>	Check.
Brakes		
Function properly.	<input type="checkbox"/>	Apply brakes. Check the wheelchair cannot be moved.
Footrests		
Footrests are securely attached.	<input type="checkbox"/>	Check.

Frame		
Cross-folding wheelchair folds and unfolds easily.	<input type="checkbox"/>	Fold the wheelchair to check that the folding mechanisms are working correctly.
Fold-down backrest – the backrest folds and unfolds easily.	<input type="checkbox"/>	
Cushion		
The cushion is in the cover correctly.	<input type="checkbox"/>	Usually the cushion cover is done up at the back of the cushion, underneath.
The cushion is sitting on the wheelchair correctly.	<input type="checkbox"/>	If the cushion is contoured, the “well” for the seat bones should be at the back of the seat.
The cushion cover fabric is tight but not too tight.	<input type="checkbox"/>	The cushion cover should not stretch tightly over any contours of the cushion.
The cushion fully covers the seat.	<input type="checkbox"/>	Check that no part of the seat is visible from under the cushion. This is particularly important for solid seats.

Cushion fabrication

If foam is available, wheelchair service personnel can make a foam pressure relief cushion with just a few tools.

Personnel need to know what foam to use, and a few important dimensions. Discuss with your trainers the foams that you have available in your location, to find out which ones would be suitable for a pressure relief cushion.

The instructions below show how to make a basic foam pressure relief cushion, with two key contours. These are a “well” under the seat bones and a shelf in front of the seat bones.

Cushion features and dimensions

The main features of the basic foam contoured cushion are the following.

A base layer, made with a firm foam (for example “chip” foam)

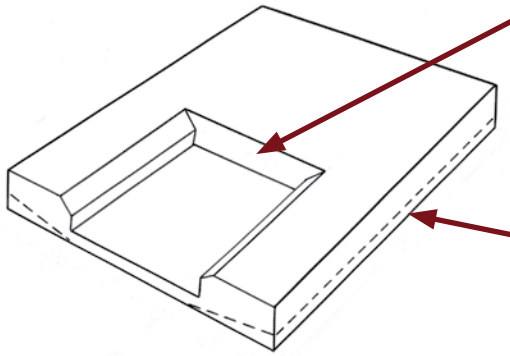
**Seat bones well**

- Relieves pressure under the seat bones and coccyx (tail bone).
- Helps to hold the pelvis upright at the back of the cushion.

Slung seat base

- Cushions used on a slung wheelchair seat have a bevel cut on each side of the base of the cushion.
- This allows the cushion to take up the shape of the slung wheelchair seat. The top of the cushion then stays flat.

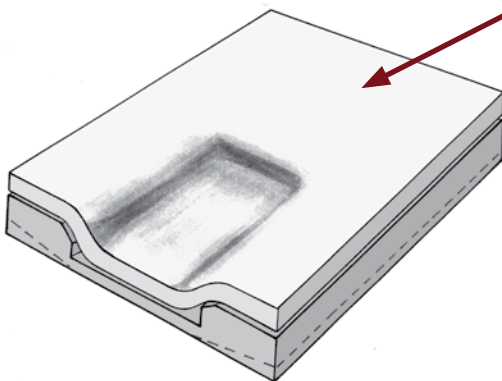
A top layer, made with a soft “comfort” foam**Top comfort layer:**

- Provides comfort over the firm base layer.

How to make a pressure relief cushion base?

The following instructions provide a cushion of dimensions 400 mm wide x 400 mm deep x 50 mm high. The seat bones well is 200 mm wide x 200 mm deep x 35 mm high. This cushion would be suitable for a wheelchair user with a seat width of 400 mm.

Adapt the dimensions to suit the size of each wheelchair user as described in the box below.

I. Mark out the cut lines on the firm foam.

- Start with a piece of firm foam 400 mm x 400 mm x 50 mm.
- The centre of the seat bones well must be on the centre line of the cushion.
- For this size cushion, the seat bones well should measure 200 mm x 200 mm x 35 mm.
- Draw the cut lines with a dark coloured marker on all six sides of the base foam.

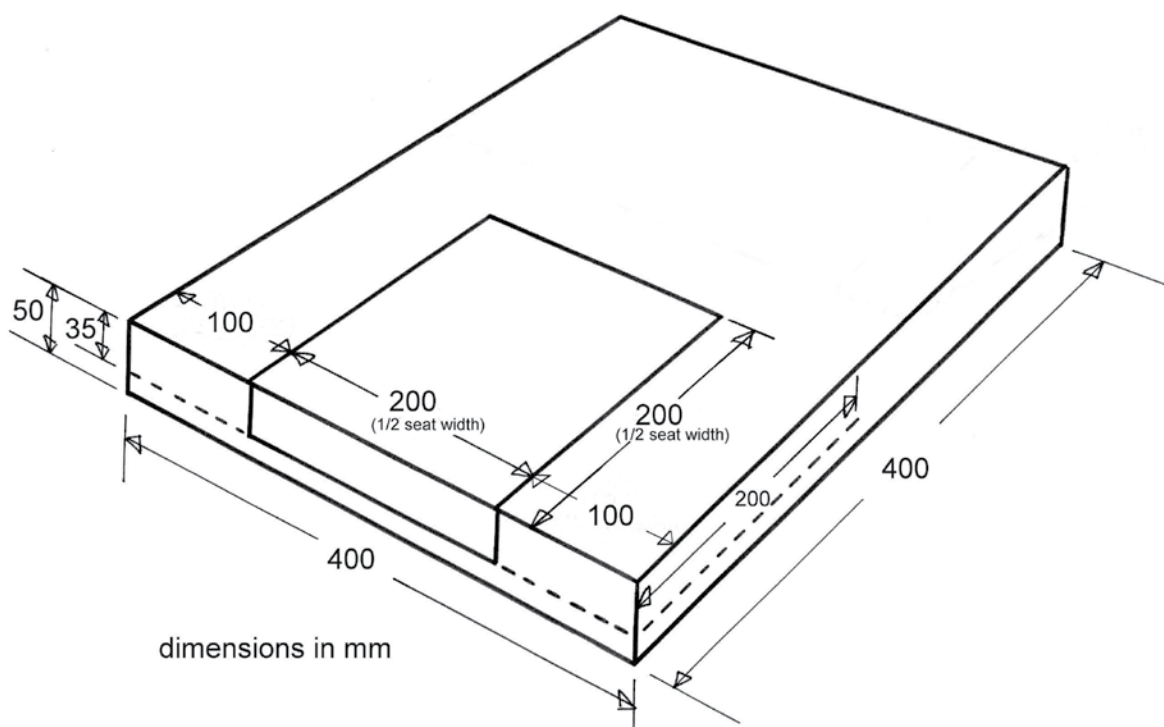

Seat bones well dimensions

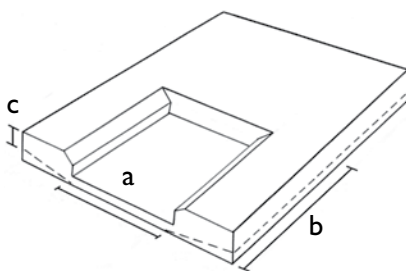

Adjust the dimensions of the cushion and the seat bones well to suit individual wheelchair users as follows:

- seat bones well width = $\frac{1}{2}$ the wheelchair user's seat width or 200 mm (whichever is less) [a];
- seat bones well depth (front to back) = $\frac{1}{2}$ the wheelchair user's seat width or 200 mm (whichever is less) [b];
- seat bones well height = 35 mm for adults and 20–25 mm for children [c].

2. Cut out the seat bones well: Use a sharpened hacksaw blade or long knife. Use long slow strokes, cutting mostly when pulling to improve control.

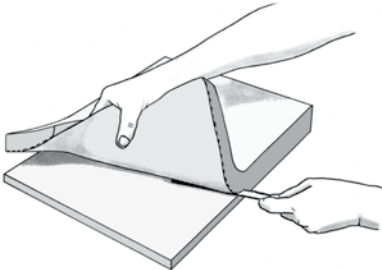

- First cut through the back of the cushion to the depth of the seat bones well.



- Then slice out the seat bones well.

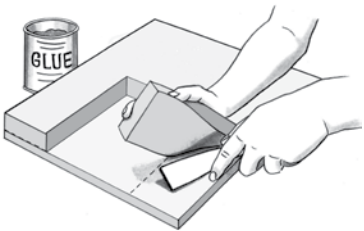

- Glue back into place the two “flaps” left on either side of the seat bones well. Allow the glue to set until not completely dried and slightly sticky to touch. Then press the foam together.

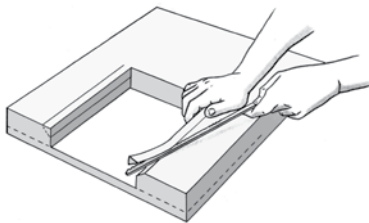

3. Cut off (bevel) the corners inside the seat bones well.

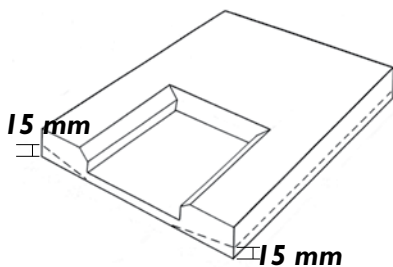

4. For a slung seat cushion: make an angled cut (bevel) on both sides of the base (under-side).

- Mark out as shown and cut.
- This cut helps the base of the cushion to match the shape of a slung wheelchair seat.

5. Place the top foam layer on top of the cushion.

- Both the base and top layer are placed in the cushion cover together.
- The two layers do not need to be glued together.
- If the top layer becomes soiled or worn, it can be washed and dried, or replaced.
- A lift can be added within the cover to increase the depth of the seat bones well.

Frequently asked questions about foam pressure relief cushions:

How do you decide which fabric to use for the cushion cover?

- Choose a fabric which is stretchy if possible. Water-resistant fabric is very good if available. If the fabric is water-resistant make sure it is not too thick, or the folds may cause marking on the wheelchair user's skin, which can lead to a pressure sore.
- The choice will depend on the fabric available. Sometimes the choice is limited.
- If there is a choice and you are not sure, ask wheelchair users to trial different options.
- Wheelchair service personnel will develop experience as different fabrics are tried.

Does this cushion work for all users?

- No – this cushion will not work for all wheelchair users.
- However, one advantage of this cushion is that it can be easily adapted.

Is this cushion hot or does it cause sweating?

- Foam cushions can be hot and can cause sweating.
- However, the cushion performs well in many other ways, so putting up with the heat is a compromise.

Do all wheelchair users need a pressure relief cushion?

- No – not all wheelchair users need a pressure relief cushion.
- Consider the pressure risk factors taught in this training programme to decide whether a wheelchair user is at risk of developing a pressure sore.
- Although this cushion may not be needed for pressure relief, the cushion can also improve comfort and posture, even for wheelchair users who are not at risk of developing pressure sores.

What happens if the cushion is used back-to-front or upside down?

- It will not work properly and may even increase the risk of developing pressure sores.
- Always make sure that wheelchair users, and family members (where relevant), understand how to use and care for the cushion correctly.
- Mark the cushion “front” and “back” or “up” and “down” if necessary.

Does this cushion work for children?

- Yes, this cushion would work for children. However, the seat bone well needs to be smaller. See above for how to work out the dimensions for a child-size cushion.
- Many children who use wheelchairs need additional postural support. This cushion may not provide enough postural support.

Cushion fit

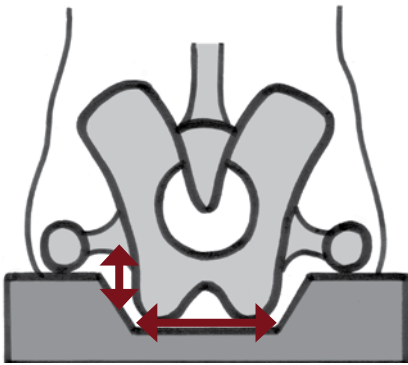

Always check that the seat bones sit just within the seat bone well and not on the edge or on the high part of the cushion.

Always check when fitting a pressure relief cushion for a wheelchair user that:

- the pressure under the seat bones is “safe” (see “How to test if a pressure relief cushion is working”, above); *and*
- the seat bones are sitting inside the seat bone well and not on the edge or top layer.

Step 6: Fitting

What does fitting involve?

During fitting, the wheelchair user and personnel together check that:

- the wheelchair is the correct size and all the necessary modifications and adjustments have been made to ensure an optimum fit;
- the wheelchair and cushion support the wheelchair user in sitting upright;
- if a pressure relief cushion has been prescribed, the cushion really relieves pressure.

Good practice in fitting



- Wherever possible, the same person who carried out the assessment should carry out the fitting.
- Always check the fit with the wheelchair stationary, and then while the wheelchair user self-propels or is pushed.
- Carry out fitting in this order:
 - check size and adjustments;
 - check posture;
 - check pressure;
 - check fit while the wheelchair user is moving.
- Use the fitting checklist provided to remember each step.

Check size and adjustments

Seat width	
Correct fit:	Should fit closely
	<p><i>How to check</i></p> <ul style="list-style-type: none"> • Run your fingers between the outside of the wheelchair user's thighs and the sides of the wheelchair. Your fingers should fit comfortably without being pinched.
	<p>Make sure the sides of the wheelchair do not press into the wheelchair user's legs. This is particularly important for a wheelchair user who cannot feel pressure on the thighs (does not have normal sensation). Firm pressure on thighs from the side of the wheelchair could cause a pressure sore.</p>
Seat depth	
Correct fit:	Two-finger gap (30 mm) between the back of the knee and the cushion.

Continues..



Continued

	<p>How to check</p> <ul style="list-style-type: none"> • Check the wheelchair user is sitting upright. • Slide hand between the cushion and the back of the knee. There should be a gap large enough to admit two fingers (30mm). There may be a bigger gap for wheelchair users with long legs. Up to 60 mm is acceptable. • Slide hand down the back of the calf and make sure it is not touching the seat or cushion. • Always check both sides.
	<p>Correct fit gives the thigh good support. This will reduce pressure under the seat bones and helps to stop pressure sores. If the seat length is too long, the user will not be able to sit upright.</p> <p>If there is a difference between right and left sides, use the shorter leg measurement to make prescription choices.</p>
<h3>Footrests height</h3>	
<p>Correct fit:</p>	<p>The thighs are fully supported on the cushion with no gaps. The feet are fully supported on the footrests with no gaps.</p>
	<p>How to check</p> <ul style="list-style-type: none"> • Slide hand between the thigh and the cushion. There should be even pressure along the thigh and no gaps. • Look at each foot on the footrest. The foot should be supported at the front and the back with no gaps. <p>If there are gaps under the thigh, the footrest may be too high. If there are gaps under the foot, the footrest may be too low.</p>

<h3>Backrest height</h3>	
<p>Correct fit:</p>	<p>The correct fit should give the wheelchair user the support he/she needs and allow an active person the freedom to move the shoulders to push.</p>
<p>How to check</p> <ul style="list-style-type: none"> • Ask the wheelchair user whether the backrest is comfortable. • Observe whether the trunk is balanced over the hips. • Is the wheelchair user able to push the wheelchair without the backrest interfering? <p>The height of the backrest depends on the needs of the user. Wheelchair users who push themselves need a backrest which allows their shoulders to move freely. Wheelchair users who have difficulty sitting upright may need a higher backrest which gives more support to the spine.</p> <p>There are two backrest height measurements on the wheelchair assessment form (see session Step 2: Assessment under the section "Taking measurements"). Take both measurements, as sometimes it is not clear in the assessment which height backrest will be most comfortable for the wheelchair user.</p>	

Continues..

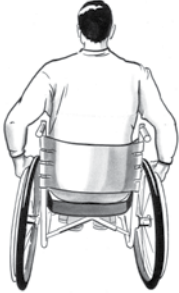
Continued

	<p>A backrest which provides support up to the bottom of the wheelchair user's rib cage is a good height if the wheelchair user:</p> <ul style="list-style-type: none"> • is fit and active; • can sit upright easily with good balance; • will be actively propelling himself/herself and needs good freedom of movement. <p><i>Backrest height D (bottom of rib cage)</i></p>
	<p>A backrest which provides support up to the bottom of the wheelchair user's shoulder blades is a good height if the wheelchair user:</p> <ul style="list-style-type: none"> • is likely to get tired quickly, e.g. elderly or with a progressive disease; • has some difficulty sitting upright. <p>This backrest height still allows some freedom of movement around the shoulders for the wheelchair user to propel the wheelchair with the arms.</p> <p><i>Backrest height E (bottom of shoulder blades)</i></p>

Rear wheels position – for hand propelling

<p>Correct fit:</p>	<p>When hands are placed on the push rims, the user's elbows should be at a right angle.</p>
	<p>How to check</p> <ul style="list-style-type: none"> • Ask the wheelchair user to grip the push rims at the top of the wheels. The elbow should be bent at 90 degrees. • Also check with the user if the rear wheels are positioned correctly for balance (forward for active, back for safe). <p>If the wheelchair user needs the rear wheels to be positioned in the "safe" (further back) position, this may mean that the arms are further back and that is ideal for propelling. Explain this compromise to the wheelchair user.</p> <p>If any adjustments are made to the rear wheels position, the brakes will also need to be adjusted and rechecked.</p>

Seat height—for foot propelling

<p>Correct fit:</p>	<ul style="list-style-type: none"> • With the wheelchair user sitting upright, and the back of the pelvis comfortably supported by the backrest, he/she should be able to rest the feet flat on the floor.
---------------------	---

Continues..

WHEELCHAIR

SERVICE TRAINING PACKAGE

Continued

	<p>How to check</p> <p>Ask the wheelchair user to sit with the back of their pelvis against the backrest with the pushing foot flat on the floor. Check whether the feet can sit flat on the floor.</p> <hr/> <p>If the seat height is too high, wheelchair service personnel can try:</p> <ul style="list-style-type: none"> • reducing the height of the cushion; • attaching a solid seat lower than the original seat (get technical advice or support to do this). <p>For a user who is propelling with only one foot, with the other foot resting on the footrest – check the pressure under the seat bone of the side that is resting on the footrest (please refer to session A. 7: Cushions, section “How to test if a pressure relief cushion is working”).</p>
---	---

Check posture



Observe how the wheelchair user is sitting in the wheelchair from the side, and from the front. Is the user sitting in an upright posture?



Some wheelchair users like to have their feet tucked in underneath them. Some wheelchair designs allow for this. If the wheelchair user is comfortable and feels balanced, this is fine.

Check pressure



For every wheelchair user at risk of developing a pressure sore – check if the pressure under the seat bones is safe.

Check fit while the wheelchair user is moving

The final part of fitting is to check how the wheelchair fits when the wheelchair user is moving. If a wheelchair user cannot push the wheelchair independently, ask a family member/caregiver to push the wheelchair.



What to look for:

- Does the backrest allow the wheelchair user freedom to move the shoulders to push?
- Do the wheelchair user's feet stay on the footrests?
- Is the rear wheel position correct for the user?

Wheelchair fitting checklist

1. Is the wheelchair ready?

Has the wheelchair been checked to make sure it is safe to use and all parts are working?	<input type="checkbox"/>
---	--------------------------

2. Check size and adjustments



Seat width Should fit closely.		<input type="checkbox"/>	Seat depth Two fingers' gap between the back of the knee and the seat/cushion.		<input type="checkbox"/>
Footrests height: The thigh is fully supported on the cushion, with no gaps. Each foot is fully supported on the footrest, with no gaps.					<input type="checkbox"/>

Continues..

WHEELCHAIR

SERVICE TRAINING PACKAGE

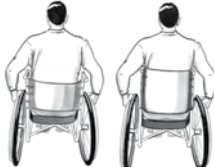

Continued

<p>Backrest height: The wheelchair user has the support they need and freedom to move their shoulders to push (if self-propelling).</p>		<input type="checkbox"/>
<p>Rear wheels position (for hand propelling): The wheelchair user's arm should be in line with the rear axle when hanging down. When hands are placed on the push rim, the user's elbow should be at a right angle.</p>		<input type="checkbox"/>
<p>Brakes: Are the brakes working?</p>		<input type="checkbox"/>
<p>Seat height (for foot propelling): With the wheelchair user sitting upright, the back should be comfortably supported by the backrest, with feet resting flat on the floor.</p>		<input type="checkbox"/>

3. Check posture

<p>Is the wheelchair user able to sit upright comfortably?</p>	<input type="checkbox"/>
<p>Check posture from the side.</p>	<input type="checkbox"/>
<p>Check posture from front/back.</p>	<input type="checkbox"/>

4. Check pressure

<p>Check pressure under seat bones for all wheelchair users at risk of developing a pressure sore.</p>		
		<p>Explain the test to the wheelchair user.</p>
<p>B</p>		<p>Ask wheelchair user to lean forward or push up. Place fingertips under wheelchair user's seat bone.</p>

Continues..

Continued

C		<p>Ask the wheelchair user to sit back down on your fingers. Make sure the user sits upright with hands on thighs.</p>
D	<p>Identify the pressure:</p> <p>Level 1 = safe: Fingertips can wriggle up and down 5 mm or more.</p> <p>Level 2 = warning: Fingertips cannot wriggle, but can easily slide out.</p> <p>Level 3 = unsafe: Fingertips are squeezed firmly. It is difficult to slide fingers out.</p>	
E	<p>Repeat under the second seat bone.</p>	

5. Check fit while the wheelchair is moving

Does the backrest allow the wheelchair user freedom to move the shoulders to push?	<input type="checkbox"/>
Does the backrest give the wheelchair user enough support?	<input type="checkbox"/>
Do the wheelchair user's feet stay on the footrests?	<input type="checkbox"/>
Is the rear wheels position correct for the user?	<input type="checkbox"/>

6. Action?

Is any further action necessary? Write any actions in the wheelchair user's file.	<input type="checkbox"/>
---	--------------------------

Remember: The next step after fitting is user instruction.

Problem solving

Sometimes personnel will find a problem with making the available wheelchair fit the wheelchair user correctly. The problem may be because:

- there is a limited range of wheelchairs and sizes available;
- the wheelchair user needs extra support to sit upright comfortably.

Below are some simple solutions to some common problems. Making modifications and providing more postural support is covered in much greater detail in the intermediate-level training.

All of these solutions assume that the closest-size wheelchair for the wheelchair user has already been selected from those available. Always check this before modifying a wheelchair.

Problem: Seat depth too short

If the seat depth (front to back) is more than 100 mm shorter than the wheelchair user's seat depth (for an adult), this is a problem. The wheelchair user will not have enough support from the seat to be able to sit comfortably. Pressure relief is also reduced. The seat depth needs to be lengthened.

Solution: Three different solutions are described below:

Solution	Caution
1. Lengthen the wheelchair seat depth by extending the seat rails and replacing upholstery.	
<ul style="list-style-type: none"> If the wheelchair is a folding-frame type, check whether the seat rails are "dedicated". This means the seat rails are not also part of the wheelchair frame. In this case, an extension can be made to the seat rails and new upholstery made to the correct length. 	
2. Lengthen the wheelchair seat depth by replacing the upholstery.	
<p>If the wheelchair is a rigid frame wheelchair with upholstery, check if the seat rail extends beyond the seat.</p> <p>In this case, it may be possible to replace the seat upholstery with new upholstery made to the correct length.</p>	
3. Lengthen the wheelchair seat depth by adding a rigid board with a cushion.	
<ul style="list-style-type: none"> A solid seat can be made from wood, plastic or any other rigid material which will not flex or crack. The seat can be fixed to the top of the seat rails. Add a cushion that is the same width and depth as the new seat. 	<ul style="list-style-type: none"> Make sure the new seat is strong enough to carry the weight of the user. Check that the seat does not flex or crack beyond the existing wheelchair seat. Always ensure a rigid seat is provided with a cushion – for every wheelchair user. Check during fitting that the backrest and footrests are the correct height. The solid seat and the cushion will raise the wheelchair user in the wheelchair.

Problem: Seat depth too long.

If the shortest available seat depth is too long, it will be impossible for the wheelchair user to sit upright. The seat depth needs to be shortened.

Solution: One solution is described below.

Solution	Caution
1. Shorten the wheelchair seat depth.	
<ul style="list-style-type: none"> • Mark the seat depth that is needed on the existing seat. • If the seat is upholstered: remove the upholstery, shorten it (using an industrial sewing machine) and replace. • If the seat is rigid: remove the seat, shorten and replace. • Shorten the cushion to match the new seat depth. 	<ul style="list-style-type: none"> • When cutting a rigid seat – always ensure that all edges are smooth and splinter-free. • When cutting a cushion – always cut from the front, so that pressure relief at the back of the cushion stays the same.

Problem: Footrests height too low.

If the footrests height is too low, the wheelchair user will not be able to rest the feet comfortably on the footrests. This can cause him/her to slide forward in the wheelchair, or to feel unstable. There will not be enough support to sit upright comfortably. The footrests will need to be raised.

Solution: Two solutions are described below.

Solution	Caution
1. Raise the footrests height by – shortening the footrests hanger.	
<ul style="list-style-type: none"> • On most four-wheel wheelchairs, the footrests hanger can be cut shorter. 	Always check that the adjustment mechanism is still working.
2. Raise the footrests by – building up the footrests	
<ul style="list-style-type: none"> • Use wood or another sturdy material to add height to the footrests. 	Check that the build-up does not stop footrests that move out of the way for transfers from working.

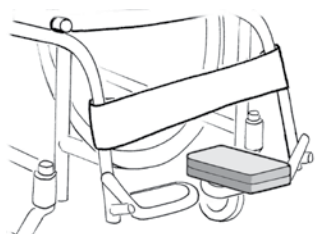

Footrest raised by building up the footrest (in this illustration one side only has been built up to accommodate shortening of one leg).

Problem: Footrests height too high.

If the footrests height is too high, the wheelchair user's thighs will not rest comfortably on the seat. Footrests that are too high can increase pressure on the seat bones. The footrests will need to be lowered.

Solution: Two possible solutions are described below.

Solution	Caution
<p>1. Lower the footrests by – lengthening the inner extension tube.</p> <ul style="list-style-type: none"> • Check if the inner extension tube can be replaced with a longer tube. • If so – replace it with a similar tube of the same diameter and strength. 	<p>Make sure the footrests do not become so low that they catch on the ground. If this happens, try option 2 instead. If this does not work, the wheelchair is not suitable for the wheelchair user.</p>
<p>2. Increase the height of the cushion.</p> <ul style="list-style-type: none"> • Increase the height of the cushion or raise the cushion by adding something solid underneath. 	<p>Do not use soft foam to increase the height of the cushion. This will compress, and will also feel unstable.</p> <p>Check during fitting that the backrest is the correct height. The higher cushion will raise the wheelchair user in the wheelchair.</p> <p>Check that there are no functional problems with raising the cushion. For example – the wheelchair user may then not be able to fit under tables or desks.</p>

Problem: Legs tend to roll inwards or outwards.

Sometimes the wheelchair user's legs roll inwards or outwards. This may be because of the way they are used to sitting, or have a physical reason (for example muscle weakness). Simple adjustments to the wheelchair seat or cushion can help to reduce this problem.

Solution: Three possible solutions are described below.

Solution
<p>1. Double check the footrests height.</p> <p>Make sure the footrests height is supporting the wheelchair user correctly (even pressure should be felt under the feet and under the thighs).</p>
<p>2. Check the seat is properly tensioned.</p> <ul style="list-style-type: none"> • If the wheelchair has an upholstered seat – make sure that the seat is tensioned firmly. • If the seat is saggy, this will encourage the wheelchair user's legs to roll inwards.
<p>3. Add wedges to the cushion to support the thighs in neutral (as in DVD and illustration) or provide a contoured cushion, modify cushion if necessary.</p> <ul style="list-style-type: none"> • Some contoured pressure relief cushions have a rise between the thighs, which will help to keep legs comfortably apart. The rise can be increased to provide additional support if needed. • Some contoured pressure relief cushions have “gutters” for the legs to rest in. The edges of the gutter can be increased to stop legs from rolling outwards.



Wedge added to the centre front of a cushion to help keep a wheelchair user's legs slightly apart.

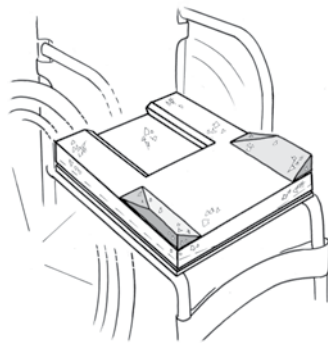

Wedges added to the front side of a cushion to help keep a wheelchair user's legs from falling outwards.

Problem: Feet tend to slide off the footrests

Sometimes the wheelchair user's feet slide off the footrests. This often has a physical reason (for example muscle weakness or muscle spasms).

Solution: Three solutions are described below.

Solution	Caution
1. Double check the footrests height.	
<ul style="list-style-type: none"> • Make sure the footrests height is supporting the wheelchair user correctly (even pressure should be felt under the feet and under the thighs). 	
2. Adjust the footrests angle (if possible).	
<ul style="list-style-type: none"> • Check if the footrests angle can be adjusted. • If so – try increasing the angle of the footrests. This may help to hold the wheelchair user's foot in place. 	Check that there is still even pressure under the foot.
3. Add a strap.	
<ul style="list-style-type: none"> • Attach a strap to the footrests hangers at the level of the ankles. • If the feet tend to slide off backwards, the strap goes behind the legs. • If the feet tend to slide off forwards, the strap goes in front of the legs. 	<p>Make sure the strap is easy to remove, so that the wheelchair user can get in and out of the wheelchair without effort.</p> <p>Check that the wheelchair user can reach the strap without assistance, and can do it up and undo it easily.</p>

WHEELCHAIR

SERVICE TRAINING PACKAGE



A calf strap can help to keep a wheelchair user's legs in place.

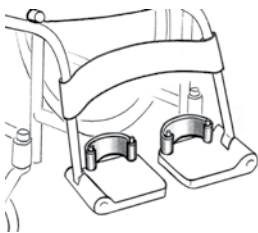

Straps at the back of the foot can provide more support, helping to prevent a wheelchair user's legs from sliding off the back of the footrests.

Problem: Wheelchair is too wide.

Sometimes the smallest wheelchair available is still too wide for the wheelchair user. If the wheelchair seat is too wide, the wheelchair user will find it difficult to sit upright, and is likely to collapse to one side. Some simple foam inserts can help to provide the wheelchair user with support to sit upright.

Solution: One solution is described below.

Solution	Caution
<p>I. Add foam inserts on each side of the pelvis.</p> <ul style="list-style-type: none"> • Measure the space between the wheelchair user (sitting central in the wheelchair with the back against the backrest) and the side of each armrest. • Cut and add foam inserts to fill the space between each side of the wheelchair user and the side of the wheelchair. • Check fit. • Upholster and attach the foam inserts. If the armrests are solid, the inserts may be attached to the armrests. They may also be attached to the top of the cushion. 	<p>The inserts only need to come as far forward as the user's trunk.</p> <p>Ensure the cushion matches the seat width.</p> <p>If the wheelchair is very wide, the wheelchair user will also have trouble reaching the push rims. Overreaching for the push rims can cause a shoulder injury. Consider carefully whether the wheelchair is safe for the wheelchair user before prescribing (selecting) it.</p>

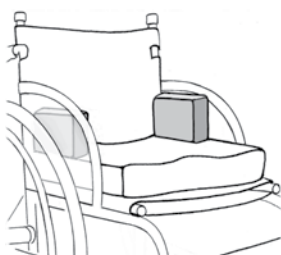

Foam inserts can reduce the inside width of the wheelchair.

Step 7: User training

Information and training about the wheelchair can help many wheelchair users really benefit from their wheelchair. Without this step, it is possible that the wheelchair will not help the wheelchair user as much as it could.

What are helpful skills for wheelchair users?



The six most important things to remember to teach are:

- how to handle the wheelchair;
- how to get in and out of the wheelchair (transfer);
- wheelchair mobility – matched to the user's needs;
- how to prevent pressure sores and what to do if a pressure sore develops;
- how to care for the wheelchair and cushion at home;
- what to do if there is a problem.

The checklist on the next page lists specific skills that a wheelchair user may need to learn. Some wheelchair users will already have these skills; and not all skills are important for all wheelchair users.

Personnel can use the checklist to select the training the wheelchair user needs. This is decided through the assessment, and through talking to the wheelchair user. Some services may use this checklist as a form, kept in the wheelchair user's file. In this case, the checklist can also be used to record the training which has been given.

Always check with the wheelchair user whether he/she would like caregivers to learn the skills you are teaching as well. Many wheelchair users are supported by their family or a caregiver, and it is helpful for everyone involved to learn how to use and care for the wheelchair.

How to make wheelchair user training successful

- Find out what the wheelchair user already knows.
- Explain, demonstrate and then allow the wheelchair user to practise.
- Use language that everyone can understand.
- Have wheelchair users teach other wheelchair users.
- Use good communication skills.
- Be encouraging.

Wheelchair user training checklist

	Skills to teach	Skills taught
Wheelchair handling		
Folding the wheelchair	<input type="checkbox"/>	<input type="checkbox"/>
Lifting the wheelchair	<input type="checkbox"/>	<input type="checkbox"/>
Using quick-release wheels	<input type="checkbox"/>	<input type="checkbox"/>
Using the brakes	<input type="checkbox"/>	<input type="checkbox"/>
Using the cushion including positioning correctly	<input type="checkbox"/>	<input type="checkbox"/>
Transfers		
Independent transfer	<input type="checkbox"/>	<input type="checkbox"/>
Assisted transfer	<input type="checkbox"/>	<input type="checkbox"/>
Other	<input type="checkbox"/>	<input type="checkbox"/>
Wheelchair mobility		
Pushing correctly	<input type="checkbox"/>	<input type="checkbox"/>
Up and down a slope	<input type="checkbox"/>	<input type="checkbox"/>
Up and down a step	<input type="checkbox"/>	<input type="checkbox"/>
On rough ground	<input type="checkbox"/>	<input type="checkbox"/>
Partial wheelie	<input type="checkbox"/>	<input type="checkbox"/>
Preventing pressure sores		
Checking for pressure sores	<input type="checkbox"/>	<input type="checkbox"/>
Pressure relief lifts	<input type="checkbox"/>	<input type="checkbox"/>
Eat well and drink lots	<input type="checkbox"/>	<input type="checkbox"/>
What to do if a pressure sore develops	<input type="checkbox"/>	<input type="checkbox"/>
Looking after the wheelchair at home		
Clean the wheelchair; wash and dry the cushion and cushion cover	<input type="checkbox"/>	<input type="checkbox"/>
Oil moving parts	<input type="checkbox"/>	<input type="checkbox"/>
Pump the tyres if they are pneumatic	<input type="checkbox"/>	<input type="checkbox"/>
Tighten nuts and bolts	<input type="checkbox"/>	<input type="checkbox"/>
Tighten spokes	<input type="checkbox"/>	<input type="checkbox"/>
Check upholstery	<input type="checkbox"/>	<input type="checkbox"/>
Check for rust	<input type="checkbox"/>	<input type="checkbox"/>
Check the cushion	<input type="checkbox"/>	<input type="checkbox"/>
What to do if there is a problem		
Wheelchair needs repairs	<input type="checkbox"/>	<input type="checkbox"/>
The wheelchair does not fit or is not comfortable	<input type="checkbox"/>	<input type="checkbox"/>

Step 8: Maintenance, repairs and follow up

Regular care of a wheelchair and cushion will save costs for repairs, extend the life of the wheelchair and prevent injuries and long-term damage to the user's body. A wheelchair which is cared for will be more comfortable, energy-efficient and easier to use. A cushion which is cared for will continue to provide pressure relief and support.

Wheelchair service personnel have a responsibility to inform wheelchair users how to care for their wheelchair and cushion at home.

Prevent repairs: home maintenance





There are six things that wheelchair users can do at home to look after their wheelchair and cushion. Show wheelchair users how to care for their wheelchair and cushion at home, and explain why it is important. The table on the next page explains what needs to be done, why it is important and how to do it.

Local resources for wheelchair repairs

Find out who can help repair wheelchairs in your local area. Possible places or people are:



- bicycle repairer;
- motorcycle or car mechanic;
- workshops – welder, plumber (metal parts), carpenter, furniture maker (wooden parts);
- wheelchair user, wheelchair user's family member, relative or neighbour;
- tailor for repairing upholstery;
- wheelchair service facilities.

How to care for a wheelchair at home

	Why is this important?	How to do it
<p>1. Clean the wheelchair and cushion</p> 	<p>Stops metal parts from rusting.</p> <p>Stops wooden parts and upholstery from rotting.</p> <p>Stops damage caused by dirt scraping against moving parts.</p>	<p>Use warm water with a little soap.</p> <p>Rinse and dry.</p> <p>Pay attention to moving parts, and where upholstery joins the frame.</p> <p>Remove cushion from cover and wash separately.</p> <p>Always dry the cushion in the shade – not in direct sun.</p>
<p>2. Oil moving parts</p> 	<p>Keeps parts moving smoothly.</p> <p>Helps stop rust.</p>	<p>Clean and dry the wheelchair first.</p> <p>Use a lubricating oil, for example bearing oil.</p> <p>Apply to all moving parts.</p>
<p>3. Pump up tyres (if pneumatic)</p> 	<p>Tyres will last longer.</p> <p>It is easier to propel the wheelchair, taking less energy.</p> <p>Brakes will work correctly.</p>	<p>Press thumb across the tyre to check pressure. It should be possible to depress the tyre very slightly (about 5 mm).</p> <p>Pressure should be the same on each tyre.</p> <p>Pump up using a bicycle pump or similar. Reduce pressure by releasing air through the valve.</p>
<p>4. Tighten nuts and bolts (if loose)</p> 	<p>Loose bolts cause unwanted movement in parts.</p> <p>This can be uncomfortable, and cause parts to wear out or be lost.</p>	<p>Check wheelchair for loose bolts or nuts. Tighten loose bolts or nuts with a wrench.</p> <p>Do not overtighten.</p>

Continues..

Continued

	Why is this important?	How to do it
<p>5. Tighten spokes (if loose)</p> 	<p>Loose spokes can cause wheels to buckle and collapse.</p>	<p>Squeeze together two spokes all the way around the wheel. If a spoke “gives” when you pull gently, it may be too loose. Tighten with a spoke wrench.</p> <p>Spokes can be overtightened. If the spoke feels very rigid, it is probably too tight and should be loosened.</p>
<p>6. Make regular checks</p>		
<p>Check for rust and check upholstery</p> 	<p>Rust reduces the strength of materials.</p> <p>This can cause parts to break and may cause injury to the user.</p> <p>Upholstery needs to be in good condition to support the wheelchair user and provide good comfort.</p> <p>If upholstery rips suddenly, the wheelchair user may be injured.</p>	<p>Check painted metal surfaces for rust/corrosion.</p> <p>If rust is found, use sandpaper or steel brush to remove the rust.</p> <p>Clean with a thinner and cloth and repaint.</p> <p>Look for tears, wears, dirt or metal parts sticking out.</p> <p>Check the tension of seat and backrest is correct.</p> <p>If the upholstery is torn or the tension of a slung seat is too loose, repairs are needed.</p>
<p>Check the cushion</p> 	<p>Cushions should be clean and dry to help protect skin.</p> <p>Cushions do not last as long as wheelchairs.</p> <p>A regular check will help wheelchair users to recognize when the cushion needs replacing.</p>	<p>Remove the cover.</p> <p>Check for worn spots, dirt and holes in the cover and foam.</p> <p>If the cushion is worn, it should be checked by the wheelchair service personnel. It may need to be replaced.</p>

Common wheelchair and cushion repairs

Wheelchairs and cushions will sometimes need to be repaired. Wheelchair service personnel need to be able to either carry out a repair, or advise wheelchair users where they can get help. Some wheelchair users will be very good at organizing their own repairs. Other wheelchair users may need help. All wheelchair users will benefit from knowing where they can get their wheelchair and cushion repaired.

What is follow up and how does it happen?

Follow up happens after the wheelchair user has received their wheelchair and has been using it for a while. Follow up appointments are an opportunity to:

- gather information from the wheelchair user;
- check that the wheelchair is in good working order;
- check the fitting of the wheelchair.

All users will benefit from a follow up visit. However, follow up is most important for:

- children;
- wheelchair users at risk of developing a pressure sore;
- wheelchair users who have a progressive condition;
- wheelchair users who have had difficulty with any of the training or instruction given to them.

There is no rule about when follow up should happen though one follow up session within six weeks of the date of delivery is often found to be useful. It will depend on the needs of the user. However, for children, it is ideal if follow up occurs every six months. This is because the needs of children change quickly as they grow.

Follow up can be carried out either at a home visit, at a centre or at any other location that suits the user and the wheelchair personnel. This depends on whether the wheelchair user is able to travel to the centre, and whether wheelchair service personnel are able to travel to the user's home.

Common follow up actions

- Check that the wheelchair is in good order;
- Provide more tips or training;
- If needed,
 - re-adjust the wheelchair;
 - carry out minor repairs or home maintenance;
 - organize major repairs or assist the wheelchair user to arrange for repairs.

The form on the next page can be used to guide follow up. Personnel should make a note of any action that is needed after the follow up visit.

Ways to manage follow up appointments

- Give wheelchair users a follow up appointment when they receive their wheelchair.
- Visit wheelchair users at home for follow up, where possible.
- Make follow up visits part of routine visits to communities by community-based rehabilitation (CBR) personnel who have been trained to carry out follow up.
- Arrange a follow up phone call if transport is difficult and the wheelchair user has access to a phone.

Wheelchair Follow Up Form

This form is for recording information from a follow up visit.

1. Wheelchair user information

Name: _____ Number: _____

Date of fitting: _____ Date of follow up: _____

Name of person carrying out follow up: _____

User's home Wheelchair service centre Other: _____

Follow up carried out at: _____

2. Interview

Record action to be taken:

Are you using your wheelchair as much as you would like?	Yes <input type="checkbox"/> No <input type="checkbox"/>	
If no – why not?		
Do you have any problems using your wheelchair?	Yes <input type="checkbox"/> No <input type="checkbox"/>	
If yes – what are the problems?		
Do you have any questions about using your wheelchair?	Yes <input type="checkbox"/> No <input type="checkbox"/>	
If yes – what questions. Is further training needed?		
Does the wheelchair user have any pressure sores?	Yes <input type="checkbox"/> No <input type="checkbox"/>	
If yes – describe (location and grade)		
How would you rate your satisfaction with your wheelchair from 1–5? (1 is not satisfied and 5 is very satisfied)	Rate:	
Comment:		

3. Wheelchair and cushion check

Is the wheelchair in good working order and safe to use?	Yes <input type="checkbox"/> No <input type="checkbox"/>	
Is the cushion in good working order and safe to use?	Yes <input type="checkbox"/> No <input type="checkbox"/>	
If no for either, what is the problem?		

4. Fitting check

Does the wheelchair fit correctly?	Yes <input type="checkbox"/> No <input type="checkbox"/>	
If no – what is the problem?		
Pressure test level (1 = safe, 2 = warning, 3 = unsafe) (if user is at risk of developing a pressure sore)	Left:	
	Right:	
Is the wheelchair user sitting upright comfortably when still, moving, and through the day?	Yes <input type="checkbox"/> No <input type="checkbox"/>	
If no – what is the problem?		

For more information, contact.

World Health Organization
20, Avenue Appia
CH-1211 Geneva 27
Switzerland

Tel.: (+ 41 22) 791-2715
Fax: (+ 41 22) 791-4874

www.who.int/disabilities/en/

ISBN 978 92 4 150347 1



9 789241 503471